

**Breadman®**

INSTRUCTION  
MANUAL &  
RECIPE GUIDE



AUTOMATIC BREAD MAKER



## TABLE OF CONTENTS

Important Safeguards . . . . .	1
Additional Important Safeguards . . . . .	2
Short Cord Instructions . . . . .	2
Electric Power . . . . .	2
Polarized Plug . . . . .	2
Power Outage . . . . .	3
Before Using For The First Time . . . . .	4
Breadman® Pro Tips . . . . .	4
Your Breadman® Pro . . . . .	5
Control Panel . . . . .	6
Kneading And Baking Courses . . . . .	7 - 8
Kneading And Baking Course Chart . . . . .	9 - 10
Know Your Ingredients . . . . .	11 - 14
Measuring Your Ingredients . . . . .	14
Recipe Tips . . . . .	15 - 16
Making Dough And Baking Bread . . . . .	17 - 20
Using The 18-Hour Delay Bake Timer . . . . .	21
Bread Recipes...As Easy As 1-2-3 . . . . .	22
White Course Bread Recipes . . . . .	22 - 31
Whole Wheat Course Bread Recipes . . . . .	32 - 40
French Course Bread Recipes . . . . .	40 - 41
Fruit & Nut Course Bread Recipes . . . . .	41 - 47
Deluxe Super Rapid Breads Method and Recipes . . . . .	48 - 52
Day Old Bread Recipes . . . . .	53
Batter Bread™ Course Recipes . . . . .	54 - 58
Bread/Pizza/Pasta Dough Courses . . . . .	59
Making Doughs: Crust Treatments . . . . .	60
Dough Course Recipes...As Easy As 1-2-3 . . . . .	61 - 78
Pizza Dough Recipes . . . . .	79 - 81
Pasta Dough Recipes . . . . .	82 - 84
Cookie Dough Recipes. . . . .	85
Jam Course Method and Recipes...As Easy As 1-2-3 . . . . .	86 - 87
User Maintenance Instructions, Cleaning and Storage . . . . .	88
Before Calling For Service . . . . .	89
Checklist . . . . .	90
Suggestions . . . . .	91
Specifications . . . . .	92
Recipe Index . . . . .	93 - 96



# IMPORTANT SAFEGUARDS

When using electrical appliances, basic safety precautions should always be followed including the following:

1. Read all instructions.
2. Do not touch hot surfaces. Use handles or knobs.
3. To protect against electrical shock do not immerse cord, plugs, or appliance in water or other liquid.
4. Close supervision is necessary when any appliance is used by or near children.
5. Unplug from outlet when not in use and before cleaning. Allow to cool before putting on or taking off parts.
6. Do not operate any appliance with a damaged cord or plug, or after the appliance malfunctions or has been damaged in any manner. Contact Consumer Service for examination, repair or electrical or mechanical adjustment.
7. The use of accessory attachments not recommended by the appliance manufacturer may cause fire, electric shock or injury.
8. Do not use outdoors.
9. Do not let cord hang over edge of table or counter, or touch hot surfaces, including the stove.
10. Do not place on or near a hot gas or electric burner, or in a heated oven.
11. Extreme caution must be used when moving an appliance containing hot oil or other hot liquids.
12. To disconnect, press and hold the STOP Button for 2 seconds, remove plug from wall outlet.
13. Do not use appliance for other than intended use.
14. Avoid contacting moving parts.

## SAVE THESE INSTRUCTIONS

**FOR HOUSEHOLD USE ONLY**



## ADDITIONAL IMPORTANT SAFEGUARDS

**CAUTION HOT SURFACES:** This appliance generates heat and escaping steam during use. Proper precautions must be taken to prevent the risk of burns, fires, or other injury to persons or damage to property.

**CAUTION:** During use, the internal parts of the Bread Maker and the area around the Steam Vent are **HOT. Keep out of reach of children to avoid possible injury.**

1. A person who has not read and understood all operating and safety instructions is not qualified to operate this appliance. All users of this appliance must read and understand this Instruction Manual before operating or cleaning this appliance.
2. If this appliance falls or accidentally becomes immersed in water, unplug it from the wall outlet immediately. **Do not reach into the water!**
3. When using this appliance, provide adequate air space above and on all sides for air circulation. Do not operate this appliance while it is touching or near curtains, wall coverings, clothing, dish towels or other flammable materials.
4. To reduce the risk of fire, do not leave this appliance unattended during use.
5. If this appliance begins to malfunction during use, immediately unplug the cord. Do not use or attempt to repair a malfunctioning appliance!
6. The cord to this appliance should only be plugged into a 120V AC electrical wall outlet.
7. Do not use this appliance in an unstable position.

## SHORT CORD INSTRUCTIONS

A short power-supply cord is provided to reduce the risk resulting from becoming entangled in or tripping over a longer cord.

Do not use an extension cord with this product.

## ELECTRIC POWER

If electric circuit is overloaded with other appliances, your Bread Maker may not operate properly. The Bread Maker should be operated on a separate electrical circuit from other operating appliances.

## POLARIZED PLUG

This appliance has a polarized plug (one blade is wider than the other). To reduce the risk of electric shock, this plug is intended to fit into a polarized outlet only one way. If the plug does not fit fully in the outlet, reverse the plug. If it still does not fit, contact a qualified electrician. Do not attempt to modify the plug in any way.



## POWER OUTAGE

### **60-Minute Power Failure Back-Up**

Your Breadman® Automatic Bread Maker has a 60-Minute Power Failure Back-Up feature. If the electricity goes off, the memory will store the Course in process for up to 60 minutes. If the power comes back on within this time, the Course will resume where it left off. If the Breadman® loses power for more than 60 minutes and you are using any dairy products, perishables or meat in your bread, you should discard the contents of the recipe and start again with new fresh ingredients due to health and sanitary considerations.

For non-perishable recipes you may try starting the Breadman® at the beginning of the Course again. However, this may not always produce an acceptable loaf of bread. If you are not sure when the outage occurred, remove the dough ball from the Bread Pan and place in an oven-safe baking container. Allow to double in size and place in a preheated 350°F/177°C oven for 30 to 45 minutes or until done. The bread will sound hollow when tapped on top of the loaf if it is done. Again, this may not always produce an acceptable loaf of bread.

If the bread has already begun to bake when the outage occurs, you must begin with new ingredients.

**NOTE: *Power Failure Back-Up does not cover surges. If you experience frequent surges, please use a surge protector.***



## BEFORE USING FOR THE FIRST TIME

1. Unpack and clean your Breadman® Automatic Bread Maker; see CLEANING INSTRUCTIONS. When the Breadman® is packaged for shipment, a clear plastic film is placed over the Control Panel; carefully peel it off.
2. Place the Breadman® on a dry, stable surface away from heat and away from areas where cooking grease or water may splatter onto it. Avoid placing the Bread Maker where it may tip over during use. Place away from edge of the counter top.
3. The Breadman® will bake up to a 2 pound loaf of bread. Do not put a larger quantity of ingredients into the Bread Pan than recommended. If you do so, the bread may not mix or bake correctly and the Breadman® may be damaged. The maximum amount of ingredients to be used is as follows.
  - Bread Courses approximately 4 cups
  - Batter Breads™ and prepackaged cake mixes 4 cups
  - Dough Courses 4-2/3 cups
  - Jam 3 cups fruit
4. Before first use, operate Breadman® empty on the Rapid White Course program to burn off the manufacturing oils. Follow the instructions outlined in the MAKING DOUGH AND BAKING BREAD section of this Instruction Manual.

**NOTE: During first use, this product may smoke and/or emit an odor from mineral oils used in manufacturing. This is normal for a newly manufactured appliance.**

## BREADMAN® TIPS

1. Remember to insert the Kneading Paddle first, then add all your ingredients BEFORE inserting the Bread Pan into the Baking Chamber of your Breadman®.
2. To insert the Bread Pan in the Breadman®, seat it firmly in place.
3. To remove the Bread Pan from the Baking Chamber, hold the Handle with an oven mitt and lift gently. When you remove the Bread Pan after baking, BE SURE TO WEAR OVEN MITTS to prevent burning. After you remove the loaf (by turning the Bread Pan upside down and shaking gently), check to see that the Kneading Paddle is removed from the loaf. If it is stuck in your bread, use a non-metal utensil to gently remove it, taking care not to scratch the Kneading Paddle.

### Inserting and Removing the Bread Pan



## YOUR BREADMAN®

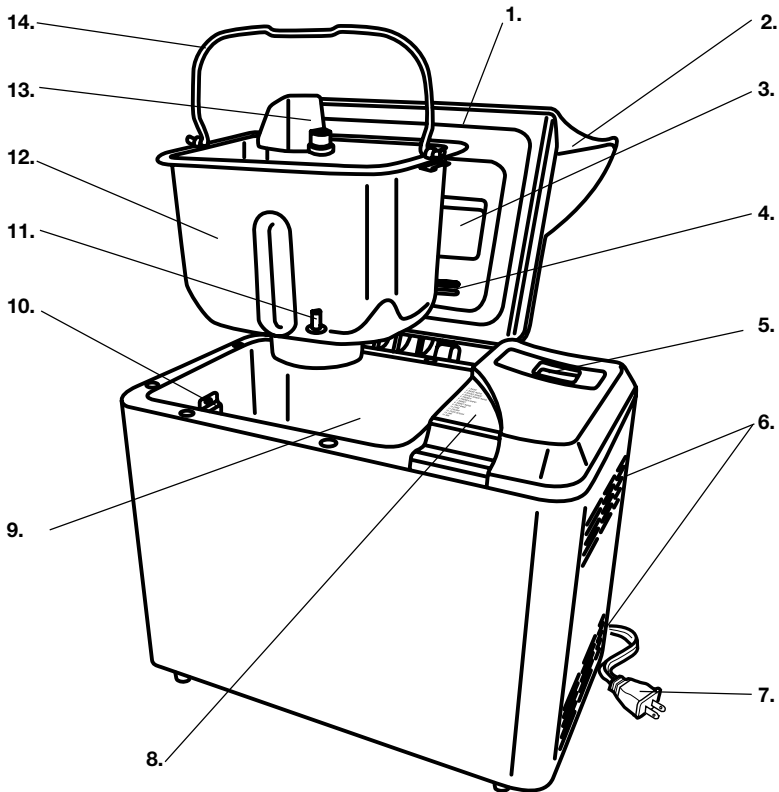

- |                                      |                                 |
|--------------------------------------|---------------------------------|
| 1. Removable Lid (P/N 20774)         | 8. Course Selection             |
| 2. Handle                            | 9. Oven (Baking Chamber)        |
| 3. Viewing Window                    | 10. Bread Pan Clip              |
| 4. Air Vent                          | 11. Drive Shaft                 |
| 5. Control Panel                     | 12. Bread Pan (P/N 20275)       |
| 6. Steam Vents                       | 13. Kneading Paddle (P/N 20274) |
| 7. Electric Cord with Polarized Plug | 14. Bread Pan Handle            |



## CONTROL PANEL

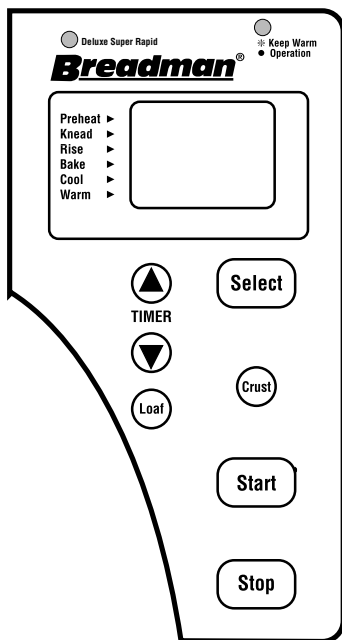

### Display Window

Shows your Selection and Timer setting.

### Operation/Keep Warm Light

The Operation/Keep Warm Light illuminates when the **START** Button is activated; when the Breadman® is completed and in Keep Warm phase, the Light will flash.

**NOTE:** When you press the ▲ or ▼, **SELECT**, **START**, or **STOP** Button, you should hear a beep. This lets you know you've pressed hard enough and your selection was made.

### Selection Options

Select from these Bread/Dough Courses:

1. White
2. Rapid White
3. Whole Wheat
4. Rapid Whole Wheat
5. French
6. Rapid French
7. Fruit & Nut
8. Rapid Fruit & Nut
9. Deluxe Super Rapid
10. Batter Breads™
11. Dough
12. Pizza Dough
13. Jam
14. Pasta Dough

### Select

Press this Button to select the Bread/Dough Course you want. Each time the **SELECT** Button is pressed, a new Course number will appear in the Display Window. (The selections will be displayed in the order listed.)

### Crust Control

Select the Crust Color: Light, Medium or Dark. The Breadman® is preset to Medium.

### Loaf Size

Select the Loaf Size: 1.0 LB, 1.5 LB, or 2.0 LB. The Breadman® is preset to 2.0 LB.

### Start

Press this Button to start the Baking Course you choose.

### 18-Hour Delay Bake Timer

Use this pair of Buttons to add or subtract time displayed in the Display Window.

▲ Use this Button to advance the Timer at 10 minute intervals.  
(*Hint: Hold down the Button for fast forward.*)

▼ Use this Button to set the Timer back at 10 minute intervals.  
(*Hint: Hold down the Button for fast reverse.*)

### Stop

Press and hold this Button for 2 seconds to clear the display, to reset the Baking Course or Delay Bake Timer setting, or to simply stop baking.





## KNEADING AND BAKING COURSES

### PLEASE NOTE:

If, at any time during the bread making process, you need to turn the Breadman® OFF, press the **STOP** Button. Then unplug the unit.

**After Kneading,  
an audible beep  
will sound**

**60 Minute  
Keep Warm phase**

- 3 Dough-Only Courses: Dough, Pizza Dough and Pasta Dough.
- During all Courses except Jam, **an audible beep will sound** to check the dough ball and scrape ingredients from the sides of the Bread Pan, to add additional ingredients (i.e., raisins, nuts, and spices) or to stir ingredients. Refer to the KNEADING AND BAKING COURSES charts in this Instruction Manual to check the Display Time that the beep will sound.
- If bread is not removed immediately after baking and the **STOP** Button is not pressed, a controlled 60 minute Keep Warm phase will begin for each Course selection (except Deluxe Super Rapid, Batter Breads™ Doughs and Jam). Although this will help prevent the bread from becoming soggy, **for best results**, remove bread immediately after the baking process is complete.

### Course 1. White Bread

This Course is used for breads that primarily use white flour, although some recipes may include small amounts of whole wheat flour.

### Course 3. Whole Wheat Bread

Use this Course for recipes with significant amounts of whole wheat or rye flour, oats, or bran.

*The Whole Wheat Course begins with a rest period* during which the flours or grains absorb the liquid ingredients. Soaking causes the flour or grain to soften and helps ingredients to combine well. Generally, Whole Wheat and multi-grain breads are shorter and denser than White, French, or Fruit & Nut breads.

### Course 5. French Bread

Traditionally, French bread has a crispier crust and lighter texture than white bread. Recipes usually do not include butter, margarine, or milk.

### Course 7. Fruit & Nut

Use this Course for recipes that use fruit juice, additional sugar or added sweet ingredients such as coconut flakes, raisins, dried fruit or chocolate. Baking temperature is reduced to prevent burning.



## KNEADING AND BAKING COURSES (CONTINUED)

### **Courses: 2. Rapid White, 4. Rapid French , 6. Rapid Whole Wheat, 8. Rapid Fruit & Nut**

*The Rapid Courses:* White, French, Whole Wheat and Fruit & Nut decrease the time for making your favorite bread by approximately an hour. Choose a recipe, then simply ADD an additional-1/2 teaspoon of active dry or quick-acting yeast, whichever one you are using, to the recipe. The bread may be shorter and denser.

### **Course 9. Deluxe Super Rapid**

The Deluxe Super Rapid Course bakes breads in as little as 59 minutes!

### **Course 10. Batter Breads™**

This Course is used for recipes that contain baking powder or baking soda rather than yeast to make bread or cake rise. Cake recipes made from scratch must be specially designed for this Course. Use this Course to prepare pre-packaged cake and quick bread mixes.

### **Course 11. Dough**

Use the Bread Dough Course to prepare dough for making bread or rolls which are shaped before baking in a conventional oven.

### **Course 12. Pizza Dough**

Use the Pizza Dough Course to prepare doughs which require less kneading and rising such as pizza and focaccia dough.

### **Course 13. Jam**

Add fruit, sugar, and lemon juice for homemade jam. A great topping for homemade bread, waffles, and ice cream.

### **Course 14. Pasta Dough**

Add your favorite ingredients when you effortlessly prepare fresh pasta dough. This Course is also useful for general purpose mixing.



## KNEADING AND BAKING COURSE CHART

Course	Course Name / Size	Total Time	Preheat	1st Knead	2nd Knead	Beep Display	Rise	Punch	2nd Rise	Punch	3rd Rise	Bake	Keep Warm
1	1. White Med. 2.0 LB	3:10				2:53						50 min	
	2. White Dark 2.0 LB	3:20	—	5 min	20 min	3:03	40 min	10 sec	25 min	15 sec	50 min	60 min	60 min
	3. White Light 2.0 LB	3:00				2:43						40 min	
	4. White Med. 1.5 LB	3:05				2:48						45 min	
	5. White Dark 1.5 LB	3:15	—	3 min	22 min	2:58	40 min	10 sec	25 min	15 sec	50 min	55 min	60 min
	6. White Light 1.5 LB	2:50				2:38						35 min	
	7. White Med. 1.0 LB	3:00				2:43						40 min	
	8. White Dark 1.0 LB	3:10	—	3 min	22 min	2:53	40 min	10 sec	25 min	15 sec	50 min	50 min	60 min
	9. White Light 1.0 LB	2:50				2:33						30 min	
2	10. Rapid White Med. 2.0 LB	2:10				1:53						50 min	
	11. Rapid White Dark 2.0 LB	2:20	—	5 min	20 min	2:03	15 min	10 sec	10 min	10 sec	30 min	60 min	60 min
	12. Rapid White Light 2.0 LB	2:00				1:43						40 min	
	13. Rapid White Med. 1.5 LB	2:05				1:48						45 min	
	14. Rapid White Dark 1.5 LB	2:15	—	3 min	22 min	1:58	15 min	10 sec	10 min	10 sec	30 min	55 min	60 min
	15. Rapid White Light 1.5 LB	1:55				1:38						35 min	
	16. Rapid White Med. 1.0 LB	2:00				1:43						40 min	
	17. Rapid White Dark 1.0 LB	2:10	—	3 min	22 min	1:53	15 min	10 sec	10 min	10 sec	30 min	50 min	60 min
	18. Rapid White Light 1.0 LB	1:50				1:33						30 min	
3	19. Whole Wheat Med. 2.0 LB	3:35				2:53						45 min	
	20. Whole Wheat Dark 2.0 LB	3:43	30 min	5 min	15 min	3:01	50 min	10 sec	25 min	10 sec	45 min	53 min	60 min
	21. Whole Wheat Light 2.0 LB	3:30				2:48						40 min	
	22. Whole Wheat Med. 1.5 LB	3:32				2:50						40 min	
	23. Whole Wheat Dark 1.5 LB	3:40	30 min	3 min	17 min	2:58	50 min	10 sec	25 min	10 sec	45 min	48 min	60 min
	24. Whole Wheat Light 1.5 LB	3:27				2:45						35 min	
	25. Whole Wheat Med. 1.0 LB	3:30				2:48						40 min	
	26. Whole Wheat Dark 1.0 LB	3:38	30 min	3 min	17 min	2:56	50 min	10 sec	25 min	10 sec	45 min	48 min	60 min
	27. Whole Wheat Light 1.0 LB	3:25				2:43						35 min	
4	28. Rapid Whole Wheat Med. 2.0 LB	2:20				2:03						45 min	
	29. Rapid Whole Wheat Dark 2.0 LB	2:28	5 min	5 min	15 min	2:11	30 min	10 sec	40 min	—	—	53 min	60 min
	30. Rapid Whole Wheat Light 2.0 LB	2:15				1:58						40 min	
	31. Rapid Whole Wheat Med. 1.5 LB	2:17				2:00						42 min	
	32. Rapid Whole Wheat Dark 1.5 LB	2:25	5 min	3 min	17 min	2:08	30 min	10 sec	40 min	—	—	50 min	60 min
	33. Rapid Whole Wheat Light 1.5 LB	2:10				1:55						37 min	
	34. Rapid Whole Wheat Med. 1.0 LB	2:15				1:58						40 min	
	35. Rapid Whole Wheat Dark 1.0 LB	2:23	5 min	3 min	17 min	2:06	30 min	10 sec	40 min	—	—	48 min	60 min
	36. Rapid Whole Wheat Light 1.0 LB	2:10				1:53						35 min	
5	37. French Med. 2.0 LB	3:30				3:13						55 min	
	38. French Dark 2.0 LB	3:40	—	5 min	20 min	3:23	40 min	10 sec	30 min	10 sec	60 min	65 min	60 min
	39. French Light 2.0 LB	3:20				3:03						45 min	
	40. French Med. 1.5 LB	3:27				3:10						52 min	
	41. French Dark 1.5 LB	3:37	—	3 min	22 min	3:20	40 min	10 sec	30 min	10 sec	60 min	62 min	60 min
	42. French Light 1.5 LB	3:17				3:00						42 min	
	43. French Med. 1.0 LB	3:25				3:08						50 min	
	44. French Dark 1.0 LB	3:35	—	3 min	22 min	3:18	40 min	10 sec	30 min	10 sec	60 min	60 min	60 min
	45. French Light 1.0 LB	3:15				2:58						40 min	

*\*Whole Wheat Courses have a rest period for up to 30 minutes before kneading begins. No movement occurs in the Bread Pan. This is normal.*



## KNEADING AND BAKING COURSE CHART (CONTINUED)

Course	Course Name / Size	Total Time	Preheat	1st Knead	2nd Knead	Beep Display	Rise	Punch	2nd Rise	Punch	3rd Rise	Bake	Keep Warm
6	46. Rapid French Med. 2.0 LB	2:25				2:08						55 min	
	47. Rapid French Dark 2.0 LB	2:35	—	5 min	20 min	2:18	20 min	8 sec	45 min	—	—	65 min	60 min
	48. Rapid French Light 2.0 LB	2:15				1:58						45 min	
	49. Rapid French Med. 1.5 LB	2:22				2:05						52 min	
	50. Rapid French Dark 1.5 LB	2:32	—	3 min	22 min	2:15	20 min	8 sec	45 min	—	—	62 min	60 min
	51. Rapid French Light 1.5 LB	2:12				1:55						42 min	
	52. Rapid French Med. 1.0 LB	2:20				2:03						50 min	
	53. Rapid French Dark 1.0 LB	2:30	—	3 min	22 min	2:13	20 min	8 sec	45 min	—	—	60 min	60 min
54. Rapid French Light 1.0 LB	2:10				1:53						40 min		
7	55. Fruit&Nut Med. 2.0 LB	3:25				3:08						65 min	
	56. Fruit&Nut Dark 2.0 LB	3:35	—	5 min	20 min	3:18	40 min	10 sec	25 min	5 sec	50 min	75 min	60 min
	57. Fruit&Nut Light 2.0 LB	3:15				2:58						55 min	
	58. Fruit&Nut Med. 1.5 LB	3:22				3:05						62 min	
	59. Fruit&Nut Dark 1.5 LB	3:32	—	3 min	22 min	3:15	40 min	10 sec	25 min	5 sec	50 min	72 min	60 min
	60. Fruit&Nut Light 1.5 LB	3:12				2:55						52 min	
	61. Fruit&Nut Med. 1.0 LB	3:20				3:03						60 min	
	62. Fruit&Nut Dark 1.0 LB	3:30		3 min	22 min	3:13	40 min	10 sec	25 min	5 sec	50 min	70 min	60 min
63. Fruit&Nut Light 1.0 LB	3:10				2:53						50 min		
8	64. Fruit&Nut Rapid Med. 2.0 LB	2:50				2:33						65 min	
	65. Fruit&Nut Rapid Dark 2.0 LB	3:00	—	5 min	20 min	2:43	25 min	10 sec	55 min	—	—	75 min	60 min
	66. Fruit&Nut Rapid Light 2.0 LB	2:40				2:23						55 min	
	67. Fruit&Nut Rapid Med. 1.5 LB	2:47				2:30						62 min	
	68. Fruit&Nut Rapid Dark 1.5 LB	2:57	—	3 min	22 min	2:40	25 min	10 sec	55 min	—	—	72 min	60 min
	69. Fruit&Nut Rapid Light 1.5 LB	2:37				2:20						52 min	
	70. Fruit&Nut Rapid Med. 1.0 LB	2:45				2:28						60 min	
	71. Fruit&Nut Rapid Dark 1.0 LB	2:55	—	3 min	22 min	2:38	25 min	10 sec	55 min	—	—	70 min	60 min
72. Fruit&Nut Rapid Light 1.0 LB	2:35				2:18						50 min		
9	73. Deluxe Super Rapid 2.0 LB	:59	—	2 min	12 min	:50	14 min	—	—	—	—	31 min	—
	74. Deluxe Super Rapid 1.5 LB	:59	—	2 min	12 min	:50	16 min	—	—	—	—	29 min	—
	75. Deluxe Super Rapid 1.0 LB	:59	—	2 min	12 min	:50	18 min	—	—	—	—	27 min	—
10	76. Batter Breads™ Med.	1:30	—	1 min	3 min	1:24	2 min	2 min	1 min	2 min	—	79 min	—
	77. Batter Breads™ Dark	1:40	—	1 min	3 min	1:34	2 min	2 min	1 min	2 min	—	89 min	—
	78. Batter Breads™ Light	1:20	—	1 min	3 min	1:14	2 min	2 min	1 min	2 min	—	69 min	—
11	79. Dough 2.0 LB	1:30	—	3 min	27 min	1:08	60 min	—	—	—	—	—	—
	80. Dough 1.5 LB	1:27	—	3 min	24 min	1:05	60 min	—	—	—	—	—	—
	81. Dough 1.0 LB	1:24	—	3 min	21 min	1:02	60 min	—	—	—	—	—	—
12	82. Pizza Dough	:50	—	5 min	15 min	:38	30 min	—	—	—	—	—	—
13	83. Jam	1:05	15 min	—	—	—	—	—	—	—	—	50 min (stir)	—
14	84. Pasta Dough	0:14	—	1 min	2 min	:06	—	5 min	1 min	5 min	—	—	—

**\*Jam Course has a rest period for 15 minutes before kneading begins. No movement occurs in the Bread Pan.**

**\*\*NOTE:** If bread is not removed immediately after baking, a controlled Keep Warm phase will begin for each selection (except Deluxe Super Rapid, Batter Breads™ Doughs, Jam and Pasta Dough). While this will help reduce condensation between loaf and Bread Pan, it is best to remove bread as soon as possible after completion of the Baking phase.



## KNOW YOUR INGREDIENTS

It has been said that cooking is an art that relies on the creativity of the chef. Baking bread is much more of a science, since the process of combining flour, water and yeast results in a chemical reaction that produces bread. You must remember that when the ingredients combine with each other, they produce a specific result. Read the following information carefully to gain a better understanding of the importance each ingredient plays in the bread making process.

### **All-Purpose Flour**

All-purpose flour is a blend of refined hard and soft wheat flours ideally suited for making quick breads and cakes. The most popular brands of flour have been tested for quick bread and cakes in the Breadman® with excellent results.

### **Bran**

Bran (unprocessed) is the coarse outer portion of the wheat or rye grains that is separated from flour by sifting or bolting. It is often added to bread in small quantities for nutritional enrichment, heartiness and flavor. It is also used to enhance bread texture.

### **Bread Flour**

Bread flour is a high gluten/protein flour that typically has a higher gluten concentration than all-purpose flour. Using bread flour with the Breadman® will produce loaves with better volume and structure.

### **Cornmeal and Oatmeal**

Cornmeal and oatmeal come from coarsely ground white or yellow corn and from rolled or steel-cut oats. They are used primarily to enhance the flavor and texture of the bread.

### **Cracked Wheat**

Cracked wheat has a very coarse texture. It comes from wheat kernels cut into angular fragments. It gives whole grain breads a nutty flavor and crunchy texture.

### **Rye Flour**

Rye flour must always be mixed with a high proportion of bread flour, as it does not contain enough gluten to develop the structure for a high, even-grained loaf.

### **Self-Rising Flour**

Self-rising flour contains leavening ingredients that will interfere with bread and cake making. **Self-Rising Flour is NOT RECOMMENDED for use with your Bread Maker.**

### **7 Grain Cereal Blend**

7 grain cereal blend is a blend of cracked wheat, oats, bran, rye, cornmeal, flax seeds and hulled millet.



## KNOW YOUR INGREDIENTS (CONTINUED)

### Vital Wheat Gluten

Gluten is manufactured from wheat flour that has been treated to remove nearly all of the starch, which leaves a very high protein content. (Gluten is the protein in the wheat that makes the dough elastic.) Gluten is available at most health food stores and in the baking aisle in many markets. It is sometimes used in small portions with dense, low-gluten flours (such as whole wheat) to increase volume and lighten texture.

### Whole Wheat Flour

Whole wheat flour is milled from the entire wheat kernel, which contains the bran and germ. This high fiber flour is richer in nutrients than all-purpose or bread flour. Breads made with this flour are usually smaller and heavier than white loaves. Many recipes mix whole wheat flour with bread flour or vital wheat gluten to produce a high, light-textured bread.

### Flour Storage

Keep flour in a secure, airtight container. Keep rye and whole wheat flours stored in a refrigerator, freezer or a cool area to prevent them from becoming rancid. Allow flour to come to room temperature before using.

**NOTE: Flours, while visibly similar, can be very different by virtue of how they were ground, milled, stored, etc. You may have to experiment with different brands of flour to help you make the perfect loaf. See RECIPE TIPS Section of this Instruction Manual to assist with these experiments.**

### Yeast

Active yeast, through a fermentation process, produces carbon dioxide gas necessary to make bread rise. Yeast feeds on carbohydrates in sugar and flour to produce this gas. Three different types of yeast are available: fresh (cake), active dry and quick-acting. Quick or rapid rise or bread machine yeasts are quick-acting. **Fresh (cake) yeast is NOT RECOMMENDED for use with your Bread Maker.**

Ensure your yeast is fresh by checking its expiration date. Once a package or jar of yeast is opened, it is important that the remaining contents be immediately resealed and refrigerated or frozen for future use. Often dough that fails to rise is due to stale yeast.

The following test can be used to determine if your yeast is stale and inactive.

1. Place 1/2 cup of hot (110°F-115°F/43°C-46°C) water into a liquid measuring cup.
2. Stir 1 teaspoon of sugar into the water and then sprinkle 2 teaspoons of yeast over the surface.
3. Allow mixture to sit for 10 minutes undisturbed.
4. The mixture should foam and rise to the 1 cup mark. If this does not occur, discard this yeast and purchase fresh yeast.



## KNOW YOUR INGREDIENTS (CONTINUED)

**NOTE:** The basic bread and dough recipes in this booklet were developed using **active dry yeast**. You may use the chart below to substitute any quick-acting yeast (quick rise, fast rise or Bread Maker yeast) for the active dry yeast or vice versa.

### Conversion Chart for Quick Rise Yeast

3/4 tsp active dry yeast	=	1/2 tsp quick rise yeast
1 tsp active dry yeast	=	3/4 tsp quick rise yeast
1-1/2 tsp active dry yeast	=	1 tsp quick rise yeast
2-1/4 tsp active dry yeast	=	1-1/2 tsp quick rise yeast
1 TBL active dry yeast	=	2 tsp quick rise yeast

### Rapid Settings Additional Yeast Amounts

The Rapid Course settings for White, French, Whole Wheat and Fruit & Nut decrease the time for making your favorite bread by approximately 1 hour. Choose a recipe, then simply **ADD** an additional 1/2 teaspoon of active dry or quick-acting yeast, whichever one you are using, to the recipe. The bread may be shorter and denser.

### Sugar

Sugar is important for the color and flavor of breads. It also serves as food for the yeast since it supports the fermentation process. Recipes in this book that call for sugar require granulated sugar. Do not substitute powdered sugar. In addition, artificial sweeteners cannot be used as a substitute for sugar as the yeast will not react properly with them.

### Salt

Salt is necessary to balance the flavor of breads and cakes. Salt limits the growth of yeast. Do not increase or decrease the amount of salt shown in the recipes.

### Liquids

All liquids should be warm 80°F/27°C for all recipes. Liquids, such as milk (1%, 2%, whole and skim), water or a combination of powdered milk and water, can be used when making bread. Milk will improve flavor, provide a velvety texture and soften the crust, while water alone will produce a crispier crust. Vegetable or fruit juices and potato water may be used for flavor variety.

### Eggs

Eggs add richness and a velvety texture to bread dough and cakes. When the recipe calls for egg(s) at room temperature, large egg(s) should be used.



## KNOW YOUR INGREDIENTS (CONTINUED)

### **Fats**

Shortening, butter and oil shorten, or tenderize, the texture of yeast breads. French bread gets its unique crust and texture from the lack of fat added. However, breads that call for fat stay fresh longer. If butter is used directly from the refrigerator, it should be cut into small pieces for easier blending during the kneading process.

### **Baking Powder**

Double acting baking powder is a leavening agent used in quick breads and cakes. This type of leavening agent does not require rising time before baking, as the chemical reaction works when liquid ingredients are added and again during baking process..

### **Baking Soda**

Baking soda is another leavening agent, not to be confused or substituted for baking powder. It also does not require rising time before baking as the chemical reaction works during baking process.

## MEASURING YOUR INGREDIENTS

The most important step when using your Breadman® for making bread is measuring your ingredients. It is very important to measure each liquid and dry ingredient accurately. For best results, add ingredients into the Bread Pan in the order given in each recipe.

### **Liquid Measurements**

Use transparent plastic or glass liquid measuring cups to measure all liquid ingredients. Place the cup on a horizontal flat surface and view markings at eye level. The level of the liquid must be aligned to the appropriate mark of measurement. A “guesstimate” is not good enough, as it could throw off the critical balance of the recipe.

### **Dry Measurements**

Dry ingredients must be measured using standard size dry measuring cups. These cups are available in various sizes. Gently spoon dry ingredients into the measuring cup and level off with a knife. Do not scoop or tap measuring cup, as this will pack the ingredients. This extra amount could affect the balance of the recipe. Do not sift flour in bread making.

When measuring small amounts of dry or liquid ingredients (i.e. yeast, sugar, salt, dry milk, honey or molasses), a standard measuring spoon must be used. Measurements must be level, not heaping.

The Breadman® Bread Maker produces delicious baked goods with ease. This marvelous appliance asks only that you carefully follow the recipe instructions. In most cooking, a pinch of this and a dash of that is fine, but this is not the case for automatic Bread Makers. Using this Breadman® requires that you accurately measure each ingredient.





## RECIPE TIPS

### Creating Your Own Yeast Breads

Even the most inexperienced baker can achieve the satisfying experience of baking a loaf of bread. All of the mystery and hard work is gone. Inside this talented Breadman® is a computer brain which instructs the Bread Maker to mix the dough, knead the dough, allow it to proof (rise) and bake without you being present. The Breadman® will also prepare dough for you to shape and bake in a conventional oven. The recipes included in this book were developed for this Bread Maker. Each recipe features ingredients that best compliment a particular loaf of bread and each was tested in our Breadman®. It is extremely important not to exceed the amount of flour specified in each recipe, up to approximately 4 cups for Bread Baking Courses and 4-2/3 cups for Dough Courses, or an unsatisfactory baking performance could result. When using your own yeast bread recipes to bake an old favorite, use recipes in this cookbook as a guide for converting portions from your recipe to your Breadman®.

### Special Glazes for Yeast Breads

Give your just-baked bread a professional finish. After glazing, generously sprinkle with your choice of poppy, sesame or caraway seeds, if desired. Select 1 of the following special glazes to enhance your bread.

- **Egg Glaze:** Beat 1 large egg and 1 tablespoon of water together, brush generously over dough.  
NOTE: Apply to breads just before baking.
- **Melted Butter Crust:** Brush melted butter over just-baked bread for a softer, more tender crust.
- **Milk Glaze:** For a softer, shiny crust, brush just-baked bread with milk or cream.
- **Sweet Icing Glaze:** Mix 1 cup sifted icing sugar with 1 to 2 tablespoons of milk until smooth to make a consistent glaze. Drizzle the glaze over raisin bread or sweet breads when they are almost cool.

### Bread Mixes and Other Recipe Books

You can use prepackaged bread mixes or other bread maker recipes in your Breadman®. Follow package or recipe directions for making 1.0, 1.5 or 2.0 LB loaves. Do not exceed the Bread Pan capacity.

### Checking Dough Consistency

Although the Breadman® will mix, knead, and bake bread automatically, when baking bread from scratch, it is necessary that you learn to recognize the condition of your dough. The ratio of flour to liquid is the most critical factor in any bread recipe, yet most easily remedied. After 5 to 8 minutes in the Knead stage, open the Breadman® to check the consistency of the dough. The dough should be in a soft, tacky ball (feel sticky like scotch tape). If it is too dry, add liquid 1/2 to 1 teaspoon at a time. If it is too wet, add 1/2 to 1 tablespoon of flour at a time.



## RECIPE TIPS (CONTINUED)

### High-Altitude Baking

In high-altitude areas, over 3,000 feet, dough tends to rise faster as there is less air pressure. Therefore, less yeast is necessary. For more information on High Altitude Baking guides contact:

Colorado Cooperative Extension Resource Center

Toll free: (877) 692-9358

E-mail: [CERC@vines.colostate.edu](mailto:CERC@vines.colostate.edu)

Website: [www.ext.colostate.edu/depts/coopext](http://www.ext.colostate.edu/depts/coopext)

**In dry climates**, flour is drier and requires slightly more liquid.

**In humid climates**, flour is wetter and will absorb less liquid. Therefore less liquid is required.

### Slicing and Storing Bread

*For best results*, place the bread on a wire rack and allow to cool for 15 to 30 minutes before slicing. Use an electric knife or a serrated knife for even slices. For rectangular slices, place the loaf on its side and slice across.

Store unused bread tightly covered, (sealable plastic bags or plastic containers work well) at room temperature for up to 3 days. For longer storage, (up to 1 month) place bread in a tightly covered container in the freezer. Since homemade bread has no preservatives, it tends to dry out and become stale faster than commercially-made bread.

Leftover or slightly hardened bread may be cut into 1/2-inch or 1-inch cubes and used in recipes to make croutons, bread pudding or stuffing.

### Measurement/Conversion Chart

1-1/2 tsp	=	1/2 TBL	8 TBL	=	1/2 cup
3 tsp	=	1 TBL	12 TBL	=	3/4 cup
1/2 TBL	=	1-1/2 tsp	16 TBL	=	1 cup
2 TBL	=	1/8 cup	3/8 cup	=	1/4 cup + 2 TBL
4 TBL	=	1/4 cup	5/8 cup	=	1/2 cup + 2 TBL
5 TBL+ 1 tsp	=	1/3 cup	7/8 cup	=	3/4 cup + 2 TBL



## MAKING DOUGH AND BAKING BREAD

The following are the general steps for using the Breadman®. Depending on the Courses or recipe that you choose, some steps may not apply or there may be additional steps. Refer to the Bread, Rapid Bread, Deluxe Super Rapid Bread, Batter Breads,™ Fruit & Nut Breads, Doughs, Pizza Dough, Pasta Dough or Jam sections in this Instruction Manual.

Add all ingredients to the Bread Pan in the order listed in the recipe.

The illustrations in this instruction manual are for information purposes only. You may find your Breadman® looks different, however, the steps for operation are the same.

Always use the freshest ingredients available. By carefully following the simple recipes that come with the Breadman®, you will be able to bake delicious bread every time.

### STEP 1

**Open the Lid and remove the Bread Pan.**

Lift the Bread Pan straight up and out of the machine, using the Handle. Do not turn or shake the Bread Pan while taking it out. If the Bread Pan is bent, the temperature sensor may not work properly.

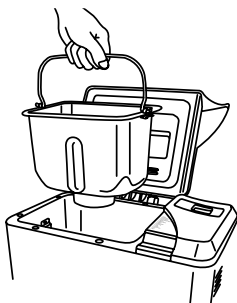

### STEP 3

**Place the ingredients into the Bread Pan.**

*For best results*, add all liquid ingredients first. Then, add all dry ingredients EXCEPT yeast, baking powder or baking soda.

**ALWAYS ADD YEAST, BAKING POWDER OR BAKING SODA LAST.**

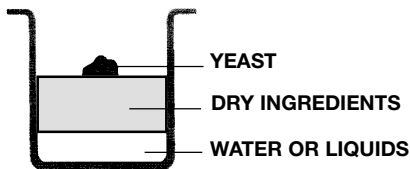

### STEP 2

**Position the Kneading Paddle on the Drive Shaft.**

Match the flat side of the Drive Shaft to the flat part of the hole in the Kneading Paddle. Make sure the Paddle is secure.

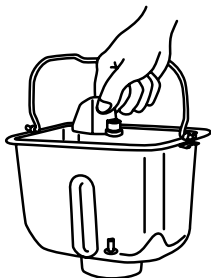

### STEP 4

**Make a small indentation on top of the dry ingredients (not so deep it reaches the wet layer) and add the yeast/baking powder/baking soda to the indentation.**

This order of adding ingredients is important, especially when using the Delay Bake Timer for yeast bread baking, because it keeps the yeast away from the wet ingredients until the Kneading process begins. (Liquid ingredients will prematurely activate the yeast.)



### STEP 5

Insert the Bread Pan into the Baking Chamber. Press down on the rim of the Bread Pan until it snaps securely into place.

If the Bread Pan does not snap securely into place, remove Bread Pan. Wearing oven mitts, place fingers behind Bread Pan clips and gently pull away from oven wall. Insert Bread Pan again.

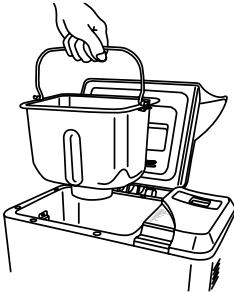

### STEP 6

Close the Lid. Plug into 120 V ~ 60 Hz outlet. The Breadman® will beep and three zeros “000” will flash in the Display Window.

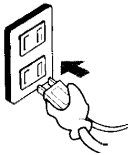

### STEP 7

Press the **SELECT** Button to choose the Course you want.

The Operation/Keep Warm Light will illuminate. Each time the **SELECT** Button is pressed, it will beep and the Indicator will move to the next Course in the Display Window.

### STEP 8

Press the **CRUST** Button to choose the **CRUST** color. The Breadman® is preset for MEDIUM CRUST color.

**NOTE:** Crust control cannot be activated for the following Courses:

- Batter Breads™
- Jam
- Dough
- Pizza Dough
- Pasta Dough

### STEP 9

Press the **LOAF SIZE** Button to select: 1.0 LB, 1.5 LB, or 2.0 LB. The Breadman® is preset to 2.0 LB.

**NOTE:** Loaf size cannot be activated for the following Courses:

- Batter Breads™
- Jam
- Pizza Dough
- Pasta Dough

**NOTE:** Although the Breadman® is capable of making 1.0 LB, 1.5 LB and 2.0 LB loaves, we recommend baking 1.5 and 2.0 LB recipes for more uniform loaves of bread. The smaller size recipes and mixes will not fill the Bread Pan when finished. This is especially true for breads that contain whole grains or other special ingredients such as Sunflower & Sesame Seed Whole Wheat Bread and Anadama Oatmeal Bread.



**NOTE:** When using the Dough, Pizza Dough, Pasta Dough, Batter Breads™ or Jam Courses, steps 7 and 8 are not needed.

### STEP 10

Press the **START** Button to begin the Kneading Course.

The Operation/Keep Warm Light will illuminate. The TIME remaining will begin to count down in the Display Window. LOAF SIZE and CRUST COLOR will be shown in the Display Window.

The Breadman® will begin mixing the ingredients for a minute. Then, it will begin the kneading process. During this process, the yeast will activate and normally the Viewing Window may begin to fog. (This will clear eventually so you can view the loaf's progress).

For the White, Whole Wheat, French, Fruit & Nut and Dough Courses, the Breadman® will beep before the end of the Kneading Course, at which time you may add any fruits or nuts, herbs, meat, garlic, etc.

**NOTE: The Beeper will sound for all Bread and Dough Courses.**

Opening the Lid will not stop the kneading process. Add ingredients quickly and evenly over dough. Quickly close Lid to prevent heat loss. At this time also check dough ball and use a rubber spatula to scrape any ingredients from the sides of the Bread Pan.

If using the Rapid Course or Delay Bake Timer, add all of the ingredients at the beginning. The ingredients will be chopped into smaller pieces.

### STEP 11

When your bread is finished baking the Breadman® will beep and “0:00” will appear in the Display Window. Press the **STOP** Button and open the Lid.

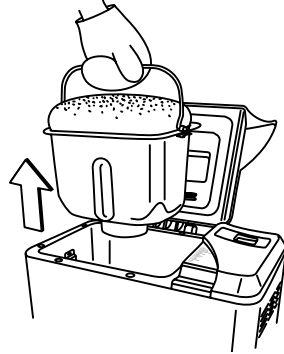

Put on oven mitts and remove the Bread Pan. **Remember that the Bread Pan and your loaf are both very hot!** Be careful not to place either on a tablecloth, plastic surface, or other heat-sensitive surface which may scorch or melt.

If the bread is not removed immediately after baking and if the **STOP** Button is not pressed, the Keep Warm controlled temperature reduction will begin. The Operation/Keep Warm Light will begin to flash. The Breadman® will automatically shut OFF; the Light will turn off after 60 minutes. Although this will help prevent the bread from becoming soggy, ***for best results,*** remove bread immediately after the baking Course is complete.

**NOTE:** The Keep Warm phase does not apply to the following Courses:

- Deluxe Super Rapid
- Batter Breads™
- Jam
- Dough
- Pizza Dough
- Pasta Dough



## STEP 12

Turn the Bread Pan upside down and shake to release the bread.

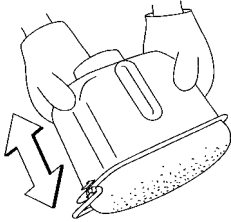

Place the bread upright on a wire rack to cool 15 to 30 minutes before cutting. This allows the steam to escape.

**CAUTION: Be sure to remove the Kneading Paddle from the bread.**

**CAUTION: The Bread Pan, Kneading Paddle and bread will be very hot.**

- Always unplug the Breadman® Bread Maker after each use.



## USING THE 18-HOUR DELAY BAKE TIMER

You can pre-program your Breadman® so that it bakes while you are at work or so that fresh bread is ready for you in the morning or the next day. Simply refer to the KNEADING AND BAKING COURSES charts in this Instruction Manual.

**Set ahead, Delay Baking does not activate in the Deluxe Super Rapid, Jam or Pasta Dough Course.**

### NOTE!

*Don't use the Delay Bake Timer if your recipe includes eggs, fresh milk, yogurt, or other dairy products, meats, etc. that may spoil.*

*To preset your Breadman®, follow these steps:*

1. Add the ingredients as usual, taking care not to let the yeast and liquid ingredients contact one another.
2. Close the Breadman® Lid and plug it in.
3. Press the **SELECT** Button to choose the Baking Course you want. The time needed for the selected Baking Course appears in the Display Window.
4. Press the **▲ TIMER** Button once for each 10 minutes you want to add. (Use the **▼ TIMER** Button to subtract time from the Timer.) The amount of time you set is shown in the Display Window.
  - To fast forward time, continually press the **▲** Button.
  - To fast reverse, continually press the **▼** Button.
  - For example, if it is 8 o'clock AM and you want a loaf of bread ready at 1 o'clock PM, press the **▲** Timer Button until the display reads 5:00, meaning it will finish baking in 5 hours. This is the hour difference between 8 o'clock AM and 1 o'clock PM.

**NOTE: Actual baking times will not change.**

5. Press the **LOAF** Button to choose loaf size, press the **CRUST** Button to choose crust color, then press the **START** Button to begin the Timer. The colon (:) in the time displayed begins to flash, letting you know the Timer is started. When your bread is finished baking the Breadman® will beep and "0:00" will appear in the Display Window. Press the **STOP** Button and open the Lid.
6. If you make an error after you've activated the program and want to start over, press and hold the **STOP** Button. The Timer will clear and you can begin again.



## BREAD RECIPES...AS EASY AS 1-2-3

We suggest starting your bread making with this White Bread Recipe. Follow the steps previously outlined in this Instruction Manual. These steps have been written to eliminate the most common errors in bread maker baking and may be helpful for any recipe.

### WHITE BREAD

Ingredients:	1.0 LB	1.5 LB	2.0 LB
Water, 80°F/27°C	3/4 cup + 1 TBL	1 cup	1-1/2 cups
Oil	1 TBL	2 TBL	2-1/2 TBL
Sugar	1-1/2 TBL	2 TBL	1/4 cup
Salt	1 tsp	1-1/4 tsp	2 tsp
Dry Milk	1 TBL	1-1/2 TBL	2 TBL
Bread Flour	2-1/4 cups	3 cups	4 cups
Active Dry Yeast	1-1/2 tsp	2 tsp	2-1/4 tsp
Select White Course	1	1	1
Select Rapid White Course	2	2	2
Active Dry Yeast	2 tsp	2-1/2 tsp	2-3/4 tsp

#### *White, Rapid White, Whole Wheat, Rapid Whole Wheat, French, Rapid French, Fruit & Nut, Rapid Fruit & Nut Course Method:*

1. Remove the Bread Pan from the Breadman®. Attach the Kneading Paddle onto the Drive Shaft. Have all ingredients ready. Make sure all ingredients, except water, are at room temperature.
2. Use a liquid measuring cup to measure the water (80°F/27°C) and pour into the Bread Pan.
3. Use a measuring spoon to measure the oil and add to the Bread Pan.
4. Use a measuring spoon to measure the sugar, salt and dry milk; level off with the straight edge of a knife and add to the Bread Pan.
5. Lightly spoon bread flour into a dry measuring cup, level off with the straight edge of a knife and add to the Bread Pan.
6. Carefully measure yeast with a measuring spoon; level off with the straight edge of a knife and add to the Bread Pan. If using Delay Bake Timer, make sure yeast is on top of bread flour, away from liquids. The Rapid setting for White Bread decreases the time for making bread by approximately an hour. Add an additional 1/2 teaspoon of active dry yeast (or quick-rise yeast) when baking rapid breads.
7. Place the Bread Pan into the Breadman®. Push down on the rim until it fits firmly into place. Close the Lid.
8. Press the **SELECT** Button; choose Course 1, White Bread. Press the **CRUST** Button to choose crust color. Press the **LOAF** Button to choose loaf size. If Delay Bake is desired, press the **▲ TIMER** Buttons to set the Delay Bake Timer and then press **START** for delay. (See DELAY BAKE TIMER section in this Instruction Manual), or press the **START** Button for an immediate start.





9. At the beep during the kneading process, check the dough ball. It will be sticky to the touch. At this time, push down any dough or flour that may be on the sides of the Bread Pan. If desired, add additional ingredients (i.e., raisins, nuts, and spices). If necessary, stir ingredients. Refer to the KNEADING AND BAKING COURSE CHART in this Instruction Manual to check the Display Time that the beep will sound.
  10. After the beeper sounds the Bread Maker will start a 60 minute Keep Warm phase. "0:00" will appear in the Display Window; the colon will begin to flash. The Operation/Keep Warm Light will flash.
  11. Press **STOP** and use oven mitts to carefully remove the Bread Pan after baking or any time during the Keep Warm phase. The Light will go out when the **STOP** Button is activated
- CAUTION: THE PAN, KNEADING PADDLE AND BREAD WILL BE VERY HOT. USE OVEN MITTS.**
12. Turn Bread Pan upside down and shake several times to release the bread. Do not use metal utensils inside the Bread Pan or Bread Machine. Remove the Kneading Paddle and allow loaf to cool standing upright on wire rack approximately 15 to 30 minutes before slicing.
  13. When the bread has completely cooled, approximately 1 hour, store in an airtight container.
  14. UNPLUG UNIT AND ALLOW TO COOL COMPLETELY BEFORE CLEANING. Clean Bread Pan after each use, DO NOT IMMERSE THE BREAD PAN IN WATER. (See CLEANING INSTRUCTIONS outlined in this Instruction Manual.) Clean inside of Breadman® after each use.

## JALAPENO BREAD

Ingredients:	1.0 LB	1.5 LB	2.0 LB
Water, 80°F/27°C	1/2 cup	3/4 cup	1 cup
Oil	1-1/2 TBL	2-1/2 TBL	3 TBL
Canned Whole Kernel Corn, well drained	1/2 cup	3/4 cup	1 cup
Jalapeno Peppers, well drained	2 TBL	3 TBL	1/4 cup
Sugar	1 TBL	2 TBL	2-1/2 TBL
Salt	1/2 tsp	1 tsp	1-3/4 tsp
Bread Flour	2 cups	3 cups	4 cups
Corn Meal	1/3 cup	1/2 cup	2/3 cup
Fresh Cilantro, chopped	2 tsp	1 TBL	4 tsp
Active Dry Yeast	1-1/2 tsp	2 tsp	2-1/4 tsp
Select White Course	1	1	1
Select Rapid White Course	2	2	2
Active Dry Yeast	2 tsp	2-1/2 tsp	2-3/4 tsp



## WHITE SOURDOUGH STARTER

### Ingredients:

Active Dry Yeast	2-1/4 tsp
Water, 110°F/43°C	2 cups
Bread Flour	3-1/2 cups
Sugar	1 TBL

In a 4 quart glass container, dissolve yeast in water, 110°F/43°C; let stand 5 minutes, add flour and sugar. Stir with plastic or wooden spoon until blended. Mixture will be thick; remaining lumps will dissolve during fermentation process. Cover loosely with plastic wrap and let stand in warm place for 5 days, stirring 3 times a day. The starter will “rise and fall” during the fermentation period and become thinner as it stands. A temperature of 80°F/27°C is best for the sour flavor to develop. An ideal place is on the counter next to your range. When the starter is developed, it is bubbly and may have a yellow liquid layer on top; stir before using. It may be used for baking or placed in the refrigerator to use later, cover loosely.

To use starter, measure the amount specified in the recipe. After refrigeration, let container of starter come to room temperature before measuring – about 4 hours. If baking in the morning, leave the starter out overnight.

Replenish with 1 cup flour, 2/3 cup water, 110°F/43°C and 1 teaspoon sugar. Stir until blended; some lumps may remain. Cover loosely and let stand in warm place for 10 to 12 hours or overnight. The starter will rise and become bubbly. Stir, then place in refrigerator to store. Stir in 1 teaspoon sugar to keep active If the starter is not used every week.

## WHITE SOURDOUGH BREAD

Ingredients:	1.0 LB	1.5 LB	2.0 LB
Water, 80°F/27°C	1/2 cup + 1 TBL	3/4 cup	3/4 cup + 1 TBL
Starter*	3/4 cup	1 cup	1-1/4 cups
Sugar	2 tsp	1 TBL	4 tsp
Salt	1 tsp	1-1/2 tsp	2 tsp
Bread Flour	2 cups	3 cups	4 cups
Active Dry Yeast	1-1/2 tsp	2 tsp	2-1/4 tsp
Select White Course	1	1	1
Select Rapid White Course	2	2	2
Active Dry Yeast	2 tsp	2-1/2 tsp	2-3/4 tsp

\*Only use Sourdough Starter recipe above.



## BANANA BREAD

<b>Ingredients:</b>	<b>1.0 LB</b>	<b>1.5 LB</b>	<b>2.0 LB</b>
Egg, large, room temperature plus enough Water, 80°F/27°C to equal	1 3/4 cup + 3 TBL	1 1 cup	1 1-1/2 cups
Oil	1 TBL	2 TBL	3 TBL
Banana Cake Mix*	1 cup	1-1/2 cups	2 cups
Bread Flour	1 cup	1-1/2 cups	2 cups
Gluten	1-1/2 tsp	2 tsp	2-1/4 tsp
Active Dry Yeast			
Select White Course	1	1	1
Select Rapid White Course	2	2	2
Active Dry Yeast	2 tsp	2-1/2 tsp	2-3/4 tsp

\*Or any other variety of cake mix for flavor variation.

## CORN BREAD

<b>Ingredients:</b>	<b>1.0 LB</b>	<b>1.5 LB</b>	<b>2.0 LB</b>
Eggs(s), large, room temperature plus enough Water, 80°F/27°C to equal	1 3/4 cup + 2 TBL	1 1 cup + 3 TBL	2 1-1/3 cups
Oil	2 TBL	3 TBL	1/4 cup
Honey	2 TBL	3 TBL	1/4 cup
Salt	1 tsp	1-1/2 tsp	2 tsp
Dry Milk	1 TBL	2 TBL	2-1/2 TBL
Bread Flour	2 cups	3 cups	4 cups
Corn Meal	1/4 cup	1/3 cup	1/2 cup
Active Dry Yeast	1-1/2 tsp	2 tsp	2-1/4 tsp
Select White Course	1	1	1
Select Rapid White Course	2	2	2
Active Dry Yeast	2 tsp	2-1/2 tsp	2-3/4 tsp



## **DILL BREAD**

<b>Ingredients:</b>	<b>1.0 LB</b>	<b>1.5 LB</b>	<b>2.0 LB</b>
Eggs(s), large, room temperature plus enough Water, 80°F/27°C to equal	1 3/4 cup + 1 TBL	2 1 cup + 1 TBL	3 1 cup + 6 TBL
Oil	1 TBL	2 TBL	3 TBL
Sugar	4 tsp	2 TBL	3 TBL
Salt	1 tsp	1-1/2 tsp	2-1/4 tsp
Bread Flour	2 cups	3 cups	4 cups
Dried Dill Weed	1-1/2 tsp	1 TBL	1-1/2 TBL
Dehydrated Onion	2 tsp	1 TBL	1-1/2 TBL
Active Dry Yeast	1-1/2 tsp	2 tsp	2-1/4 tsp
Select White Course	1	1	1
Select Rapid White Course	2	2	2
Active Dry Yeast	2 tsp	2-1/2 tsp	2-3/4 tsp

## **FAT-FREE WHITE BREAD**

<b>Ingredients:</b>	<b>1.0 LB</b>	<b>1.5 LB</b>	<b>2.0 LB</b>
Water, 80°F/27°C	3/4 cup + 1 TBL	1 cup	1-1/2 cups
Applesauce	1 TBL	2 TBL	3 TBL
Sugar	1-1/2 TBL	3 TBL	1/4 cup
Salt	1 tsp	1-1/2 tsp	2 tsp
Dry Milk	1 TBL	1-1/2 TBL	2 TBL
Bread Flour	2-1/4 cups	3 cups	4 cups
Active Dry Yeast	1-1/2 tsp	2 tsp	2-1/4 tsp
Select White Course	1	1	1
Select Rapid White Course	2	2	2
Active Dry Yeast	2 tsp	2-1/2 tsp	2-3/4 tsp



## EGG BREAD

<b>Ingredients:</b>	<b>1.0 LB</b>	<b>1.5 LB</b>	<b>2.0 LB</b>
Eggs(s), large, room temperature plus enough Water, 80°F/27°C to equal	1 3/4 cup + 1 TBL	2 1 cup + 1 TBL	2 1-1/3 cups
Oil	1 TBL	1-1/2 TBL	2 TBL
Sugar	4 tsp	2 TBL	2-1/2 TBL
Salt	1 tsp	1-1/2 tsp	2 tsp
Dry Milk	2 TBL	3 TBL	1/4 cup
Bread Flour	2 cups + 2 TBL	3 cups	4 cups
Active Dry Yeast	1-1/2 tsp	2 tsp	2-1/4 tsp
Select White Course	1	1	1
Select Rapid White Course	2	2	2
Active Dry Yeast	2 tsp	2-1/2 tsp	2-3/4 tsp

## BUTTERMILK BREAD

<b>Ingredients:</b>	<b>1.0 LB</b>	<b>1.5 LB</b>	<b>2.0 LB</b>
Cultured Buttermilk, 80°F/27°C	3/4 cup + 2 TBL	1 cup + 2 TBL	1-1/2 cups + 2 TBL
Oil	2 TBL	3 TBL	1/4 cup
Sugar	2 TBL	3 TBL	1/4 cup
Salt	1 tsp	1-1/2 tsp	2 tsp
Baking Soda	1/4 tsp	1/2 tsp	3/4 tsp
Bread Flour	2 cups	3 cups	4 cups
Active Dry Yeast	1-1/2 tsp	2 tsp	2-1/4 tsp
Select White Course	1	1	1
Select Rapid White Course	2	2	2
Active Dry Yeast	2 tsp	2-1/2 tsp	2-3/4 tsp



## HONEY GRANOLA BREAD

<b>Ingredients:</b>	<b>1.0 LB</b>	<b>1.5 LB</b>	<b>2.0 LB</b>
Water, 80°F/27°C	3/4 cup + 3 TBL	1 cup + 3 TBL	1-1/2 cups
Oil	2 TBL	3 TBL	1/4 cup
Honey	2 TBL	3 TBL	1/4 cup
Salt	1 tsp	1-1/2 tsp	2 tsp
Dry Milk	2 TBL	2-1/2 TBL	3 TBL
Bread Flour	2 cups	3 cups	4 cups
Granola Cereal	2/3 cup	3/4 cup	1 cup
Active Dry Yeast	1-1/2 tsp	2 tsp	2-1/4 tsp
Select White Course	1	1	1
Select Rapid White Course	2	2	2
Active Dry Yeast	2 tsp	2-1/2 tsp	2-3/4 tsp

## MAPLE BREAD

<b>Ingredients:</b>	<b>1.0 LB</b>	<b>1.5 LB</b>	<b>2.0 LB</b>
Water, 80°F/27°C	3/4 cup + 2 TBL	1 cup	1-1/3 cups
Oil	2 TBL	1/4 cup	6 TBL
Maple Syrup	2 TBL	1/4 cup	6 TBL
Maple Extract	1/4 tsp	1/2 tsp	3/4 tsp
Salt	1 tsp	1-1/2 tsp	2 tsp
Bread Flour	2 cups	3 cups	4 cups
Dry Oatmeal, quick or regular	3/4 cups	1 cup	1-1/2 cups
Walnuts, chopped	1/2 cup	3/4 cup	1 cup
Active Dry Yeast	1-1/2 tsp	2 tsp	2-1/4 tsp
Select White Course	1	1	1
Select Rapid White Course	2	2	2
Active Dry Yeast	2 tsp	2-1/2 tsp	2-3/4 tsp



## PEACH BREAD

<b>Ingredients:</b>	<b>1.0 LB</b>	<b>1.5 LB</b>	<b>2.0 LB</b>
Apricot Nectar, 80°F/27°C	5 TBL	3/4 cup	1 cup
Peach Yogurt, 80°F/27°C	3 TBL	1/4 cup	1/3 cup
Carrots, uncooked and grated	5 TBL	1/2 cup	3/4 cup
Oil	1 TBL	2 TBL	3 TBL
Honey	1 TBL	2 TBL	3 TBL
Salt	1 tsp	1-1/2 tsp	2 tsp
Bread Flour	2 cups	3 cups	4 cups
Active Dry Yeast	1-1/2 tsp	2 tsp	2-1/4 tsp
Select White Course	1	1	1
Select Rapid White Course	2	2	2
Active Dry Yeast	2 tsp	2-1/2 tsp	2-3/4 tsp

## POTATO BREAD

<b>Ingredients:</b>	<b>1.0 LB</b>	<b>1.5 LB</b>	<b>2.0 LB</b>
Eggs(s), large, room temperature plus enough Water, 80°F/27°C to equal	1 3/4 cup + 2 TBL	2 1-1/4 cups	2 1-1/2 cups
Oil	1 TBL	2 TBL	3 TBL
Sugar	4 tsp	2 TBL	3 TBL
Salt	1 tsp	1-1/2 tsp	2 tsp
Dry Milk	2 TBL	3 TBL	1/4 cup
White Pepper	1/8 tsp	1/4 tsp	1/4 tsp
Instant Potato Buds	1/4 cup	1/3 cup	1/2 cup
Green Onion Tops, chopped	1 TBL	1-1/2 TBL	2 TBL
Bread Flour	2 cups	3 cups	4 cups
Active Dry Yeast	1-1/2 tsp	2 tsp	2-1/4 tsp
Select White Course	1	1	1
Select Rapid White Course	2	2	2
Active Dry Yeast	2 tsp	2-1/2 tsp	2-3/4 tsp



## MILK BREAD

<b>Ingredients:</b>	<b>1.0 LB</b>	<b>1.5 LB</b>	<b>2.0 LB</b>
Milk, 80°F/27°C	3/4 cup	1 cup	1-1/2 cups
Oil	2 TBL	2 TBL	3 TBL
Sugar	1 tsp	1-1/2 tsp	2 tsp
Salt	1 tsp	1-1/2 tsp	2 tsp
Bread Flour	2 cups	3 cups	4 cups
Active Dry Yeast	1-1/2 tsp	2 tsp	2-1/4 tsp
Select White Course	1	1	1
Select Rapid White Course	2	2	2
Active Dry Yeast	2 tsp	2-1/2 tsp	2-3/4 tsp

## WHOLE GRAIN BREAD

<b>Ingredients:</b>	<b>1.0 LB</b>	<b>1.5 LB</b>	<b>2.0 LB</b>
Water, 80°F/27°C	1/4 cup	1/3 cup	1/2 cup
Cultured Buttermilk, 80°F/27°C	2/3 cup	1 cup	1-1/3 cups
Oil	2 tsp	1 TBL	1 TBL + 1 tsp
Molasses	3 TBL	1/4 cup	1/3 cup
Salt	1 tsp	1-1/2 tsp	2 tsp
Baking Soda	3/4 tsp	1 tsp	1-1/2 tsp
Oat Bran Cereal, uncooked	3 TBL	1/4 cup	1/3 cup
Corn Meal	3 TBL	1/4 cup	1/3 cup
Rye Flour	3 TBL	1/4 cup	1/3 cup
Buckwheat Flour	3 TBL	1/4 cup	1/3 cup
Whole Wheat Flour	1/3 cup	1/2 cup	2/3 cup
Bread Flour	1-1/3 cups	2 cups	3 cups
Active Dry Yeast	1-1/2 tsp	2 tsp	2-1/4 tsp
Select White Course	1	1	1
Select Rapid White Course	2	2	2
Active Dry Yeast	2 tsp	2-1/2 tsp	2-3/4 tsp





## BLOODY MARY BREAD

<b>Ingredients:</b>	<b>1.0 LB</b>	<b>1.5 LB</b>	<b>2.0 LB</b>
Water, 80°F/27°C	1/4 cup	1/4 cup	1/4 cup
Bloody Mary Mix, 80°F/27°C	1/2 cup	3/4 cup	1 cup
Green Onion tops, chopped	1 TBL	2 TBL	3 TBL
Oil	1 TBL	2 TBL	3 TBL
Sugar	1 TBL	2 TBL	3 TBL
Salt	1/2 tsp	3/4 tsp	1 tsp
Bread Flour	2 cups	3 cups	4 cups
Dried Parsley	1 TBL	2 TBL	3 TBL
Active Dry Yeast	1-1/2 tsp	2 tsp	2-1/4 tsp
Select White Course	1	1	1
Select Rapid White Course	2	2	2
Active Dry Yeast	2 tsp	2-1/2 tsp	2-3/4 tsp

## BANANA GRANOLA BREAD

<b>Ingredients:</b>	<b>1.0 LB</b>	<b>1.5 LB</b>	<b>2.0 LB</b>
Water, 80°F/27°C	3/4 cup	1 cup + 2 TBL	1-1/2 cups + 2 TBL
Oil	2 TBL	2-1/2 TBL	3 TBL
Honey	2 TBL	2-1/2 TBL	3 TBL
Banana Extract	1/2 tsp	3/4 tsp	1 tsp
Salt	1 tsp	1-1/2 tsp	2 tsp
Dry Milk	2 TBL	2-1/2 TBL	3 TBL
Bread Flour	2 cups	3 cups	4 cups
Granola Cereal	2/3 cup	3/4 cup	1 cup
Active Dry Yeast	1-1/2 tsp	2 tsp	2-1/4 tsp
<b>Add:</b>			
Banana Chips, crushed	1/3 cup	1/2 cup	2/3 cup
Select White Course	1	1	1
Select Rapid White Course	2	2	2
Active Dry Yeast	2 tsp	2-1/2 tsp	2-3/4 tsp



## SUNFLOWER & SESAME SEED WHOLE WHEAT BREAD

<b>Ingredients:</b>	<b>1.5 LB</b>	<b>2.0 LB</b>
Egg, large, room temperature plus enough Water, 80°F/27°C to equal	1	1
Oil	1 cup + 2 TBL	1-1/4 cups
Molasses	2 TBL	3 TBL
Sugar	1 TBL	2 TBL
Salt	1-1/2 tsp	2 tsp
Bread Flour	2-1/2 cups	3 cups
Whole Wheat Flour	1/2 cup	1 cup
Sesame Seeds	2 TBL	2-1/2 TBL
Cumin Seeds	1/4 tsp	1/4 tsp
Sunflower Seeds (kernels)	1-1/2 TBL	2 TBL
Active Dry Yeast	2 tsp	2-1/4 tsp
Select Whole Wheat Course	3	3
Select Rapid Whole Wheat Course	4	4
Active Dry Yeast	2-1/2 tsp	2-3/4 tsp

## WHOLE WHEAT BREAD

<b>Ingredients:</b>	<b>1.0 LB</b>	<b>1.5 LB</b>	<b>2.0 LB</b>
Egg Whites plus enough Cultured Buttermilk, /27°C to equal	1	1	1
Oil	1 cup	1 cup + 3 TBL	1-1/2 cups
Molasses	2 TBL	3 TBL	1/4 cup
Salt	2 TBL	3 TBL	1/4 cup
Baking Soda	1 tsp	1-1/2 tsp	2 tsp
Whole Wheat Flour	1/4 tsp	1/2 tsp	3/4 tsp
Active Dry Yeast	2 cups	3 cups	4 cups
Select Whole Wheat Course	1-1/2 tsp	2 tsp	2-1/4 tsp
Select Rapid Whole Wheat Course	3	3	3
Active Dry Yeast	4	4	4
Active Dry Yeast	2 tsp	2-1/2 tsp	2-3/4 tsp



## WHOLE WHEAT WITH GLUTEN BREAD

<b>Ingredients:</b>	<b>1.0 LB</b>	<b>1.5 LB</b>	<b>2.0 LB</b>
Water, 80°F/27°C	1 cup	1-1/4 cups	1-1/2 cups
Oil	1-1/2 TBL	2-1/2 TBL	3 TBL
Molasses	2 TBL	2-1/2 TBL	3 TBL
Salt	1 tsp	1-1/2 tsp	2 tsp
Dry Milk	1-1/2 TBL	2 TBL	3 TBL
Whole Wheat Flour	2-1/2 cups	3-3/4 cups	4 cups
Gluten	1-1/2 TBL	2-1/2 TBL	3 TBL
Active Dry Yeast	1-1/2 tsp	2 tsp	2-1/4 tsp
Select Whole Wheat Course	3	3	3
Select Rapid Whole Wheat Course	4	4	4
Active Dry Yeast	2 tsp	2-1/2 tsp	2-3/4 tsp

## WHOLE WHEAT CINNAMON RAISIN WALNUT BREAD

<b>Ingredients:</b>	<b>1.0 LB</b>	<b>1.5 LB</b>	<b>2.0 LB</b>
Egg White(s) room temperature plus enough Water, 80°F/27°C to equal	1 3/4 cup	2 1 cup + 2 TBL	3 1-1/2 cups
Oil	2 TBL	3 TBL	1/4 cup
Honey	2 TBL	3 TBL	1/4 cup
Salt	1/2 tsp	1-1/2 tsp	2 tsp
Cinnamon	3/4 tsp	1 tsp	1-1/4 tsp
Whole Wheat Flour	2 cups	3 cups	4 cups
Walnuts, chopped	1/3 cup	1/2 cup	2/3 cup
Active Dry Yeast	1-1/2 tsp	2 tsp	2-1/4 tsp
<b>Add:</b>			
Raisins	1/3 cup	1/2 cup	2/3 cup
Select Whole Wheat Course	3	3	3
Select Rapid Whole Wheat Course	4	4	4
Active Dry Yeast	2 tsp	2-1/2 tsp	2-3/4 tsp



## SOUTHERN BARLEY BREAD

<b>Ingredients:</b>	<b>1.0 LB</b>	<b>1.5 LB</b>	<b>2.0 LB</b>
Egg, large, room temperature plus enough Water, 80°F/27°C to equal	1	1	1
Oil	3/4 cup + 2 TBL	1 cup	1-1/4 cups
Honey	1 TBL	2 TBL	3 TBL
Salt	1 tsp	1-1/2 tsp	2 tsp
Dry Milk	2 TBL	3 TBL	1/4 cup
Barley, cooked	3 TBL	1/4 cup	5 TBL
Grits, uncooked	2 tsp	1 TBL	1-1/2 TBL
Oat Bran Cereal, uncooked	1/4 cup	1/3 cup	1/2 cup
Whole Wheat Flour	1/2 cup	1 cup	1-1/2 cups
Bread Flour	1-1/2 cups	2 cups	2-1/2 cups
Active Dry Yeast	1-1/2 tsp	2 tsp	2-1/4 tsp
Select Whole Wheat Course	3	3	3
Select Rapid Whole Wheat Course	4	4	4
Active Dry Yeast	2 tsp	2-1/2 tsp	2-3/4 tsp

## CARAWAY RYE BREAD

<b>Ingredients:</b>	<b>1.0 LB</b>	<b>1.5 LB</b>	<b>2.0 LB</b>
Eggs(s), large, room temperature plus enough Water, 80°F/27°C to equal	1	1	2
Oil	3/4 cup	1 cup + 1 TBL	1-1/3 cups
Honey	2 TBL	3 TBL	1/4 cup
Dry Milk	2 TBL	3 TBL	1/4 cup
Salt	1 TBL	2 TBL	3 TBL
Salt	1 tsp	1-1/2 tsp	2 tsp
Bread Flour	1 cup	1-1/2 cups	2 cups
Whole Wheat Flour	1/2 cup	3/4 cup	1 cup
Rye Flour	1/2 cup	2/3 cup	1 cup
Caraway Seeds	1 TBL	2 TBL	3 TBL
Active Dry Yeast	1-1/2 tsp	2 tsp	2-1/4 tsp
Select Whole Wheat Course	3	3	3
Select Rapid Whole Wheat Course	4	4	4
Active Dry Yeast	2 tsp	2-1/2 tsp	2-3/4 tsp



## ONION RYE BREAD

<b>Ingredients:</b>	<b>1.0 LB</b>	<b>1.5 LB</b>	<b>2.0 LB</b>
Eggs(s), large, room temperature plus enough Water, 80°F/27°C to equal	1	1	2
Oil	3/4 cup + 2 TBL	1 cup + 3 TBL	1-1/3 cups + 2 TBL
Honey	2 TBL	3 TBL	1/4 cup
Dry Milk	1 TBL	2 TBL	3 TBL
Salt	1 tsp	1-1/2 tsp	2 tsp
Bread Flour	1 cup	1-1/2 cups	2 cups
Whole Wheat Flour	1/2 cup	3/4 cup	1 cup
Rye Flour	1/2 cup	2/3 cup	1 cup
Caraway Seeds	1 TBL	2 TBL	3 TBL
Dehydrated Onion	2 TBL	3 TBL	1/4 cup
Active Dry Yeast	1-1/2 tsp	2 tsp	2-1/4 tsp
Select Whole Wheat Course	3	3	3
Select Rapid Whole Wheat Course	4	4	4
Active Dry Yeast	2 tsp	2-1/2 tsp	2-3/4 tsp

## ANADAMA OATMEAL BREAD

**PLEASE NOTE:** The following recipe requires a few quick preparation instructions.

- Add oatmeal and cornmeal to heat-proof bowl. Pour in boiling water, stirring to prevent lumps.
- Let the mixture cool for 20 minutes (to 80°F/27°C). Stir, pour it into the Bread Pan and add the rest of the ingredients in the order given.

<b>Ingredients:</b>	<b>1.5 LB</b>	<b>2.0 LB</b>
Boiling Water	1 cup + 2 TBL	1-1/2 cups
Oatmeal	1/4 cup	1/3 cup
Cornmeal	2 TBL	3 TBL
Oil	2 TBL	3 TBL
Molasses	2 TBL	3 TBL
Dry Milk	1/4 cup	1/3 cup
Salt	1-1/2 tsp	2 tsp
Whole Wheat Flour	1 cup	1-1/2 cups
Bread Flour	2 cups	2-1/2 cups
Gluten	2 TBL	3 TBL
Active Dry Yeast	2 tsp	2-1/4 tsp
Select Whole Wheat Course	3	3
Select Rapid Whole Wheat Course	4	4
Active Dry Yeast	2-1/2 tsp	2-3/4 tsp



## HONEY-BANANA WHOLE WHEAT BREAD

<b>Ingredients:</b>	<b>1.0 LB</b>	<b>1.5 LB</b>	<b>2.0 LB</b>
Egg, large, room temperature plus enough Water, 80°F/27°C to equal	1	1	1
Oil	3/4 cup	1 cup	1-1/4 cups
Honey	1 TBL	1-1/2 TBL	2 TBL
Vanilla	3 TBL	1/4 cup	5 TBL
Salt	1/4 tsp	1/2 tsp	3/4 tsp
Banana, mashed	1-1/2 tsp	2 tsp	2-1/2 tsp
Whole Wheat Flour	3/4 cup	1 cup	1-1/4 cups
Bread Flour	1 cup	1-1/2 cups	2 cups
Poppy Seeds	1-1/4 cups	1-1/2 cups	2 cups
Active Dry Yeast	1-1/2 tsp	2 tsp	2-1/2 tsp
Select Whole Wheat Course	3	3	3
Select Rapid Whole Wheat Course	4	4	4
Active Dry Yeast	2 tsp	2-1/2 tsp	2-3/4 tsp

## SEVEN GRAIN BREAD

<b>Ingredients:</b>	<b>1.5 LB</b>	<b>2.0 LB</b>
Egg, large, room temperature plus enough Water, 80°F/27°C to equal	1	1
Oil	1 cup + 2 TBL	1-1/2 cups
Honey	2 TBL	3 TBL
Salt	2 tsp	1 TBL
Whole Wheat Flour	1-1/2 tsp	2 tsp
Bread Flour	1-1/2 cups	2 cups
Brown Rice Flour	1/2 cup	1 cup
Spelt Flour	1/4 cup	1/3 cup
Buckwheat Flour	1/4 cup	1/3 cup
Rye Flour	1/4 cup	1/3 cup
Oatmeal	1/4 cup	1/3 cup
Cornmeal	2 TBL	1/4 cup
Gluten	3 TBL	1/4 cup
Active Dry Yeast	2 tsp	2-1/4 tsp
Select Whole Wheat Course	3	3
Select Rapid Whole Wheat Course	4	4
Active Dry Yeast	2-1/2 tsp	2-3/4 tsp



## TWO CHEESE BREAD

<b>Ingredients:</b>	<b>1.0 LB</b>	<b>1.5 LB</b>	<b>2.0 LB</b>
Egg, large, room temperature plus enough Water, 80°F/27°C to equal	1	1	1
Oil	3/4 cup	1 cup	1-1/4 cups
Honey	2 tsp	1 TBL	1-1/2 TBL
Salt	1 tsp	2 tsp	1 TBL
Dry Milk	1 tsp	1-1/2 tsp	2 tsp
Whole Wheat Flour	2 TBL	1/4 cup	1/3 cup
Bread Flour	1/4 cup	1/2 cup	3/4 cup
Grated Cheddar Cheese	1-3/4 cups	2-1/2 cups	3-1/4 cups
Grated Parmesan Cheese	2/3 cup	1 cup	1-1/3 cups
Sesame Seeds	2 TBL	3 TBL	1/4 cup
Active Dry Yeast	1 tsp	2 tsp	1 TBL
Select Whole Wheat Course	1-1/2 tsp	2 tsp	2-1/4 tsp
Select Rapid Whole Wheat Course	3	3	3
Select Rapid Whole Wheat Course	4	4	4
Active Dry Yeast	2 tsp	2-1/2 tsp	2-3/4 tsp

## WHOLE WHEAT ZUCCHINI HERB BREAD

<b>Ingredients:</b>	<b>1.5 LB</b>	<b>2.0 LB</b>
Water, 80°F/27°C		
Honey	1/2 cup	3/4 cup
Oil	2 tsp	1 TBL
Salt	1 TBL	1-1/2 TBL
Zucchini, shredded	1-1/2 tsp	2 tsp
Whole Wheat Flour	1 cup	1-1/2 cups
Bread Flour	3/4 cup	1 cup
Basil (dried)	2 cups	2-1/2 cups
or Basil (fresh)	1/2 tsp	1/2 tsp
Sesame Seeds	1 tsp	1 tsp
Active Dry Yeast	2 tsp	1 TBL
Select Whole Wheat Course	2 tsp	2-1/4 tsp
Select Rapid Whole Wheat Course	3	3
Select Rapid Whole Wheat Course	4	4
Active Dry Yeast	2-1/2 tsp	2-3/4 tsp



## YOGURT WHOLE WHEAT BREAD

<b>Ingredients:</b>	<b>1.5 LB</b>	<b>2.0 LB</b>
Plain Nonfat Yogurt, 80°F/27°C	3/4 cup	1 cup
Water, 80°F/27°C	1/4 cup	1/2 cup
Oil	1 TBL	1-1/2 TBL
Maple Syrup	1-1/2 TBL	2 TBL
Salt	1-1/2 tsp	2 tsp
Whole Wheat Flour	1-1/3 cups	1-1/2 cups
Bread Flour	1-2/3 cups	2-1/2 cups
Wheat Germ	1-1/2 TBL	2 TBL
Active Dry Yeast	2 tsp	2-1/4 tsp
Select Whole Wheat Course	3	3
Select Rapid Whole Wheat Course	4	4
Active Dry Yeast	2-1/2 tsp	2-3/4 tsp





## PUMPERNICKEL BREAD

<b>Ingredients:</b>	<b>1.0 LB</b>	<b>1.5 LB</b>	<b>2.0 LB</b>
Eggs(s), large, room temperature plus enough Water, 80°F/27°C to equal	1 3/4 cup + 1 TBL	1 1 cup + 2 TBL	2 1 cup + 6 TBL
Oil	2 TBL	3 TBL	1/4 cup
Honey	2 TBL	3 TBL	1/4 cup
Dry Milk	1 TBL	2 TBL	3 TBL
Salt	1 tsp	1-1/2 tsp	2 tsp
Bread Flour	1 cup	1-1/2 cups	2 cups
Whole Wheat Flour	1/2 cup	3/4 cup	1 cup
Rye Flour	1/2 cup	2/3 cup	1 cup
Caraway Seeds	1 TBL	2 TBL	3 TBL
Instant Coffee Granules	1 tsp	2 tsp	1 TBL
Cocoa Powder	2 TBL	3 TBL	1/4 cup
Active Dry Yeast	1-1/2 tsp	2 tsp	2-1/4 tsp
Select Whole Wheat Course	3	3	3
Select Rapid Whole Wheat Course	4	4	4
Active Dry Yeast	2 tsp	2-1/2 tsp	2-3/4 tsp

## DAIRY WHOLE WHEAT BREAD

<b>Ingredients:</b>	<b>1.0 LB</b>	<b>1.5 LB</b>	<b>2.0 LB</b>
Water, 80°F/27°C	1/4 cup	1/4 cup	1/4 cup
Milk, 80°F/27°C	1/3 cup	1/2 cup	3/4 cup
Cottage Cheese, 80°F/27°C	3 TBL	1/4 cup	1/3 cup
Oil	1-1/2 TBL	2-1/2 TBL	1/4 cup
Honey	4 tsp	2 TBL	1/4 cup
Salt	1 tsp	1-1/2 tsp	2 tsp
Whole Wheat Flour	2/3 cup	1 cup	1-1/4 cups
Bread Flour	1-1/3 cups	2 cups	2-3/4 cups
Active Dry Yeast	1-1/2 tsp	2 tsp	2-1/4 tsp
Select Whole Wheat Course	3	3	3
Select Rapid Whole Wheat Course	4	4	4
Active Dry Yeast	2 tsp	2-1/2 tsp	2-3/4 tsp



## HEARTY NUT BREAD

<b>Ingredients:</b>	<b>1.0 LB</b>	<b>1.5 LB</b>	<b>2.0 LB</b>
Water, 80°F/27°C	1 cup	1-1/4 cups	1 cup + 7 TBL
Oil	2 tsp	1 TBL	1-1/2 TBL
Molasses	3 TBL	1/4 cup	1/3 cup
Salt	1 tsp	1-1/2 tsp	2 tsp
Dry Oatmeal, quick or regular	1/3 cup	1/2 cup	2/3 cup
Whole Wheat Flour	2/3 cup	1 cup	1-1/3 cups
Bread Flour	1-1/3 cups	2 cups	2-2/3 cups
Walnuts, chopped	2/3 cup	3/4 cup	1 cup
Active Dry Yeast	1-1/2 tsp	2 tsp	2-1/4 tsp
Select Whole Wheat Course	3	3	3
Select Rapid Whole Wheat Course	4	4	4
Active Dry Yeast	2-1/4 tsp	2-1/2 tsp	2-3/4 tsp

## FRENCH BREAD

<b>Ingredients:</b>	<b>1.0 LB</b>	<b>1.5 LB</b>	<b>2.0 LB</b>
Water, 80°F/27°C	3/4 cup + 2 TBL	1 cup + 2 TBL	1-1/2 cups
Oil (optional)	1 TBL	1-1/2 TBL	2 TBL
Sugar	1 TBL	1-1/2 TBL	2 TBL
Salt	1 tsp	1-1/2 tsp	2 tsp
Bread Flour	2-1/4 cups	3-1/2 cups	4 cups
Active Dry Yeast	1-1/2 tsp	2 tsp	2-1/4 tsp
Select French Course	5	5	5
Select Rapid French Course	6	6	6
Active Dry Yeast	2 tsp	2-1/2 tsp	2-3/4 tsp



## ITALIAN HERB BREAD

<b>Ingredients:</b>	<b>1.0 LB</b>	<b>1.5 LB</b>	<b>2.0 LB</b>
Water, 80°F/27°C	3/4 cup + 2 TBL	1 cup + 1 TBL	1-1/4 cups + 2 TBL
Oil	1-1/2 TBL	2 TBL	3 TBL
Sugar	1 TBL	2 TBL	3 TBL
Salt	1 tsp	1-1/2 tsp	2 tsp
Dry Milk	1 TBL	2 TBL	3 TBL
Bread Flour	2-1/4 cups	3 cups	4 cups
Dried Italian Seasoning	1 tsp	2 tsp	1 TBL
Active Dry Yeast	1-1/2 tsp	2 tsp	2-1/4 tsp
Select French Course	5	5	5
Select Rapid French Course	6	6	6
Active Dry Yeast	2 tsp	2-1/2 tsp	2-3/4 tsp

## SPICED PUMPKIN BREAD

<b>Ingredients:</b>	<b>1.0 LB</b>	<b>1.5 LB</b>	<b>2.0 LB</b>
Eggs(s), large, room temperature plus enough Water, 80°F/27°C to equal	1 1/4 cup	2 1/2 cup	2 3/4 cup
Oil	2 TBL	3 TBL	1/4 cup
Canned Pumpkin	2/3 cup	1 cup	1-1/4 cups
Brown Sugar	2 TBL	3 TBL	1/4 cup
Salt	1 tsp	1-1/2 tsp	2 tsp
Cloves, ground	1/4 tsp	1/4 tsp	1/4 tsp
Nutmeg	1/2 tsp	3/4 tsp	1 tsp
Cinnamon	1-1/2 tsp	2-1/4 tsp	2-3/4 tsp
Bread Flour	2 cups	3 cups	4 cups
Active Dry Yeast	1-1/2 tsp	2 tsp	2-1/4 tsp
Select Fruit & Nut Course	7	7	7
Select Rapid Fruit & Nut Course	8	8	8
Active Dry Yeast	2 tsp	2-1/2 tsp	2-3/4 tsp



## CINNAMON RAISIN BREAD

<b>Ingredients:</b>	<b>1.0 LB</b>	<b>1.5 LB</b>	<b>2.0 LB</b>
Water, 80°F/27°C	3/4 cup	1 cup	1-1/4 cups + 2 TBL
Oil	1 TBL	1-1/2 TBL	2 TBL
Brown Sugar	1-1/2 TBL	2-1/2 TBL	3 TBL
Salt	1 tsp	1-1/2 tsp	2 tsp
Dry Milk	1 TBL	1-1/2 TBL	2 TBL
Cinnamon	1 tsp	2 tsp	1 TBL
Bread Flour	2-1/4 cups	3 cups	4 cups
Walnuts, chopped	1/3 cup	1/2 cup	2/3 cup
Active Dry Yeast	1-1/2 tsp	2 tsp	2-1/4 tsp

### **Add:**

Raisins	1/3 cup	1/2 cup	2/3 cup
Select Fruit & Nut Course	7	7	7
Select Rapid Fruit & Nut Course	8	8	8
Active Dry Yeast	2 tsp	2-1/2 tsp	2-3/4 tsp

## CRUNCHY CRACKED WHEAT BREAD

**PLEASE NOTE:** The following recipe requires a few quick preparation instructions.

- Add cracked wheat to heat-proof bowl. Pour in boiling water, stirring to prevent lumps.
- Let the mixture stand for 20 minutes (to 80°F/27°C). Stir, pour it into the Bread Pan, and add the rest of the ingredients in order given.

<b>Ingredients:</b>	<b>1.0 LB</b>	<b>1.5 LB</b>	<b>2.0 LB</b>
Water, Boiling	1 cup	1-1/2 cups	1-3/4 cups
Cracked Wheat	1/2 cup	3/4 cup	1 cup
Oil	1-1/2 TBL	2 TBL	3 TBL
Sugar	4 tsp	2 TBL	3 TBL
Salt	1 tsp	1-1/2 tsp	2-1/2 tsp
Bread Flour	2 cups	3 cups	4 cups
Active Dry Yeast	1-1/2 tsp	2 tsp	2-1/4 tsp
Select Fruit & Nut Course	7	7	7
Select Rapid Fruit & Nut Course	8	8	8
Active Dry Yeast	2 tsp	2-1/2 tsp	2-3/4 tsp



## SOY HERB BREAD

For best results, choose Light Crust Color.

Ingredients:	1.5 LB
Water, 80°F/27°C	1-1/4 cups
Oil	2 TBL
Sugar	3 TBL
Salt	1-1/2 tsp
Dry Milk	1 TBL
Dried Dill Weed	1 tsp
Garlic Salt	1/2 tsp
Dry Mustard	1/2 tsp
Dried Basil	1/4 tsp
Dried Oregano	1/4 tsp
Bread Flour	2-3/4 cups
Soy Flour	1/2 cup
Active Dry Yeast	2 tsp
Select Fruit & Nut Course	7
Select Rapid Fruit & Nut Course	8
Active Dry Yeast	2-1/2 tsp

## SWEET WALNUT BREAD

Ingredients:	1.0 LB	1.5 LB	2.0 LB
Water, 80°F/27°C	3/4 cup	1 cup	1-1/2 cups
Oil	1 TBL	1-1/2 TBL	2 TBL
Sugar	1-1/2 TBL	2 TBL + 1 tsp	3 TBL
Salt	1 tsp	1-1/2 tsp	2 tsp
Dry Milk	1 TBL	1-1/2 TBL	2 TBL
Bread Flour	2 cups	3 cups	4 cups
Active Dry Yeast	1-1/2 tsp	2 tsp	2-1/4 tsp
<b>Add:</b>			
Walnuts, chopped	1/3 cup	1/2 cup	2/3 cup
Select Fruit & Nut Course	7	7	7
Select Rapid Fruit & Nut Course	8	8	8
Active Dry Yeast	2 tsp	2-1/2 tsp	2-3/4 tsp



## WHITE WHEAT BREAD

<b>Ingredients:</b>	<b>1.0 LB</b>	<b>1.5 LB</b>	<b>2.0 LB</b>
Water, 80°F/27°C	3/4 cup	1 cup + 2 TBL	1-1/4 cups + 2 TBL
Oil	1 TBL	1-1/2 TBL	2 TBL
Sugar	2 TBL	3 TBL	1/4 cup
Salt	1 tsp	1-1/2 tsp	2 tsp
Dry Milk	1 TBL	1-1/2 TBL	2 TBL
Bread Flour	1-3/4 cups	2-2/3 cups	3-1/2 cups
Whole Wheat Flour	1/4 cup	1/3 cup	1/2 cup
Active Dry Yeast	1-1/2 tsp	2 tsp	2-1/4 tsp
<b>Add:</b>			
Sunflower Seeds (kernels)	2 TBL	3 TBL	1/4 cup
Select Fruit & Nut Course	7	7	7
Select Rapid Fruit & Nut Course	8	8	8
Active Dry Yeast	2 tsp	2-1/2 tsp	2-3/4 tsp

## DRIED FRUIT BREAD

<b>Ingredients:</b>	<b>1.0 LB</b>	<b>1.5 LB</b>	<b>2.0 LB</b>
Water, 80°F/27°C	3/4 cup	1 cup + 1 TBL	1-1/4 cups
Oil	2-1/2 TBL	3 TBL	1/4 cup
Brown Sugar	1-1/2 TBL	2-1/2 TBL	1/4 cup
Salt	1 tsp	1-1/2 tsp	2 tsp
Dry Milk	1 TBL	1-1/2 TBL	2-1/2 TBL
Bread Flour	2-1/4 cups	3 cups	4 cups
Nutmeg	1/2 tsp	1 tsp	1-1/2 tsp
Active Dry Yeast	1-1/2 tsp	2 tsp	2-1/4 tsp
<b>Add:</b>			
Dried Fruit	1/3 cup	1/2 cup	2/3 cup
Select Fruit & Nut Course	7	7	7
Select Rapid Fruit & Nut Course	8	8	8
Active Dry Yeast	2 tsp	2-1/2 tsp	2-3/4 tsp



## TRAIL MIX BREAD

<b>Ingredients:</b>	<b>1.0 LB</b>	<b>1.5 LB</b>	<b>2.0 LB</b>
Water, 80°F/27°C	3/4 cup	1-1/4 cups	1-1/2 cups
Oil	2 TBL	3 TBL	1/4 cup
Honey	2 TBL	3 TBL	1/4 cup
Salt	1 tsp	1-1/2 tsp	2 tsp
Bread Flour	2 cups	3 cups	4 cups
Active Dry Yeast	1-1/2 tsp	2 tsp	2-1/4 tsp
<b>Add:</b>			
Fruit & Nut Trail Mix	1/3 cup	1/2 cup	2/3 cup
Select Fruit & Nut Course	7	7	7
Select Rapid Fruit & Nut Course	8	8	8
Active Dry Yeast	2 tsp	2-1/2 tsp	2-3/4 tsp

## SOY ALMOND FRUIT BREAD

<b>Ingredients:</b>	<b>1.5 LB</b>
Water, 80°F/27°C	1 cup
Oil	3 TBL
Almond Extract	1/2 tsp
Sugar	1-1/2 tsp
Salt	1-1/2 tsp
Dry Milk	1-1/2 TBL
Bread Flour	2-1/2 cups
Soy Flour	1/2 cup
Almonds, slivered	2 TBL
Active Dry Yeast	2 tsp
<b>Add:</b>	
Dried Mixed Fruit, diced	1/2 cup
Select Fruit & Nut Course	7
Select Rapid Fruit & Nut Course	8
Active Dry Yeast	2-1/2 tsp



## SOY CINNAMON RAISIN BREAD

**NOTE:** For best results, choose Light Crust Color.

<b>Ingredients:</b>	<b>1.5 LB</b>
Water, 80°F/27°C	1 cup
Oil	3 TBL
Sugar	2 TBL
Salt	1-1/2 tsp
Dry Milk	1/4 cup
Bread Flour	2-1/2 cups
Cinnamon	1 tsp
Soy Flour	1/2 cup
Active Dry Yeast	2 tsp
<b>Add:</b>	
Raisins	1/2 cup
Select Fruit & Nut Course	7
Select Rapid Fruit & Nut Course	8
Active Dry Yeast	2-1/2 tsp

## CHEESE ONION BREAD

<b>Ingredients:</b>	<b>1.0 LB</b>	<b>1.5 LB</b>	<b>2.0 LB</b>
Water, 80°F/27°C	3/4 cup	3/4 cup + 3 TBL	1-1/2 cups
Sugar	2 TBL	3 TBL	1/4 cup
Salt	1 tsp	1-1/2 tsp	2 tsp
Bread Flour	2-1/4 cups	3 cups	4-1/4 cups
Cheddar Cheese, shredded	1/2 cup	3/4 cup	1 cup
Dehydrated Onion	1 TBL	1-1/2 TBL	2 TBL
Active Dry Yeast	1-1/2 tsp	2 tsp	2-1/4 tsp
Select Fruit & Nut Course	7	7	7
Select Rapid Fruit & Nut Course	8	8	8
Active Dry Yeast	2 tsp	2-1/2 tsp	2-3/4 tsp





## CARROT RAISIN BREAD

<b>Ingredients:</b>	<b>1.0 LB</b>	<b>1.5 LB</b>	<b>2.0 LB</b>
Egg, large, room temperature plus enough Water, 80°F/27°C to equal	1	1	1
Oil	3/4 cup	1 cup	1-1/4 cups
Sugar	2 TBL	3 TBL	1/4 cup
Salt	1-1/2 tsp	2 tsp	2-1/2 tsp
Carrots, uncooked and grated	1/2 cup	3/4 cup	1 cup
Bread Flour	2-1/4 cups	3-1/4 cups	4 cups
Apple Pie Spice	3/4 tsp	1 tsp	1-1/2 tsp
Active Dry Yeast	1-1/2 tsp	2 tsp	2-1/4 tsp
<b>Add:</b>			
Raisins	1/3 cup	1/2 cup	2/3 cup
Select Fruit & Nut Course	7	7	7
Select Rapid Fruit & Nut Course	8	8	8
Active Dry Yeast	2 tsp	2-1/2 tsp	2-3/4 tsp



## DELUXE SUPER RAPID BREADS

We suggest starting your super rapid bread baking with this Deluxe Super Rapid White Bread Recipe. Follow each step carefully, noticing that water temperatures must be 110 - 115°F/43 - 46°C and that Quick Rise, Rapid Rise, Bread Machine\* or Instant Active Dry Yeast must be used.

### *DELUXE SUPER RAPID WHITE BREAD*

<b>Ingredients:</b>	<b>1.0 LB</b>	<b>1.5 LB</b>	<b>2.0 LB</b>
Water, 100°-115°F/43°-46°C	3/4 cup +2 TBL	1 cup +2 TBL	1-1/2 cups + 2 TBL
Oil	1-1/2 TBL	2 TBL	2-1/2 TBL
Salt	1 tsp	1-1/2 tsp	2 tsp
Sugar	1 TBL	2 TBL	3 TBL
Dry Milk	1 TBL	2 TBL	3 TBL
Bread Flour	2 cups	3 cups	4 cups
Super Rapid Type Yeast	4 tsp	5-1/4 tsp	7 tsp
Select Deluxe Super Rapid Course	9	9	9



### ***Deluxe Super Rapid Method:***

1. Remove the Bread Pan from the Breadman®. Attach the Kneading Paddle onto the Drive Shaft. Have all ingredients ready. Make sure all ingredients, except water, are at room temperature.
2. Use a liquid measuring cup to measure the water (110 - 115°F/43 - 46°C) and pour into the Bread Pan.
3. Use a measuring spoon to measure the oil and add to the Bread Pan.
4. Use a measuring spoon to measure the sugar and salt; level off with the straight edge of a knife and add to the Bread Pan.
5. Lightly spoon bread flour into a dry measuring cup; level off with the straight edge of a knife and add to the Bread Pan. Smooth into all corners.
6. Carefully measure super rapid type yeast with a measuring spoon; level off with the straight edge of a knife and add to the Bread Pan.
7. Place the Bread Pan into the Breadman®. Push down on the rim until it fits firmly into place. Close the Lid.
8. Press the **SELECT** Button; choose Course 9, Deluxe Super Rapid. Press the **START** Button.
9. At the beep during the kneading process, check the dough ball. It will be sticky to the touch. At this time, push down any dough or flour that may be on the sides of the Bread Pan. and, if desired, add additional ingredients (i.e., raisins, nuts, and spices). If necessary, stir ingredients. Refer to the **KNEADING AND BAKING COURSES** charts in this Instruction Manual to check the Display Time that the beep will sound.
10. When your bread is finished baking the Breadman® will beep and “0:00” will appear in the Display Window. Press the **STOP** Button and open the Lid.
11. Use oven mitts to carefully remove the Bread Pan.

### **CAUTION: THE OVEN CAVITY, BREAD PAN, KNEADING PADDLE AND BREAD WILL BE VERY HOT. USE OVEN MITTS.**

12. Turn the Bread Pan upside down and shake several times to release the bread. Do not use metal utensils inside the Bread Pan or Breadman®. Remove the Kneading Paddle and allow loaf to cool standing upright on wire rack approximately 15 to 30 minutes before cutting.
13. When the bread has completely cooled, approximately 1 hour, store in an airtight container.
14. **UNPLUG UNIT AND ALLOW TO COOL COMPLETELY BEFORE CLEANING.** Clean Bread Pan after each use, **DO NOT IMMERSE THE BREAD PAN IN WATER.** (See **CLEANING INSTRUCTIONS** outlined in this Instruction Manual.) Clean inside of Breadman® after each use.



### *Deluxe Super Rapid Course Hints for Best Results*

- The dough ball for the Deluxe Super Rapid Course should be a very soft, sticky to the touch, loose ball with a smooth texture. Do not add extra flour.
- Check the dough ball, and if necessary, use a rubber spatula to push any flour or dough from the sides of the Bread Pan down into the dough ball.
- As a result of the increased temperatures during the rise and bake process, the loaf of bread produced from this program may have a dark, crisp crust with a split in the top of the loaf.  
\*These are special yeasts widely available in major grocery stores specifically for 59-minute super bake and super rapid breads.

## **DELUXE SUPER RAPID COUNTRY WHITE BREAD**

<b>Ingredients:</b>	<b>1.0 LB</b>	<b>1.5 LB</b>	<b>2.0 LB</b>
Cultured Buttermilk, 100°-115°F/43°-46°C	3/4 cup + 2 TBL	1 cup + 3 TBL	1-1/2 cups + 2 TBL
Oil	2 tsp	1 TBL	2 TBL
Salt	1 tsp	1-1/2 tsp	2 tsp
Sugar	1 TBL	2 TBL	3 TBL
Instant Potato Granules	3 TBL	1/4 cup	1/2 cup
Bread Flour	2 cups	3 cups	4 cups
Super Rapid Type Yeast	4 tsp	5-1/4 tsp	7 tsp
Select Deluxe Super Rapid Course	9	9	9



## **DELUXE SUPER RAPID FRENCH BREAD**

<b>Ingredients:</b>	<b>1.0 LB</b>	<b>1.5 LB</b>	<b>2.0 LB</b>
Water, 100°-115°F/43°-46°C	3/4 cup +2 TBL	1 cup + 3 TBL	1-1/2 cups + 2 TBL
Oil	1 tsp	1-1/2 tsp	2 tsp
Salt	1 tsp	1-1/2 tsp	2 tsp
Sugar	2 tsp	1 TBL	4 tsp
Bread Flour	2 cups	3 cups	4 cups
Super Rapid Type Yeast	4 tsp	5-1/4 tsp	7 tsp
Select Deluxe Super Rapid Course	9	9	9

## **DELUXE SUPER RAPID ITALIAN BREAD**

<b>Ingredients:</b>	<b>1.0 LB</b>	<b>1.5 LB</b>	<b>2.0 LB</b>
Water, 100°-115°F/43°-46°C	3/4 cup +2 TBL	1 cup + 3 TBL	1-1/2 cups + 2 TBL
Oil	1 TBL	2 TBL	3 TBL
Salt	1 tsp	1-1/2 tsp	2 tsp
Sugar	3 TBL	1/4 cup	5 TBL
Dry Milk	1 TBL	2 TBL	3 TBL
Bread Flour	2 cups	3 cups	4 cups
Super Rapid Type Yeast	4 tsp	5-1/4 tsp	7 tsp
Select Deluxe Super Rapid Course	9	9	9



## **DELUXE SUPER RAPID CINNAMON-RAISIN BREAD**

<b>Ingredients:</b>	<b>1.0 LB</b>	<b>1.5 LB</b>	<b>2.0 LB</b>
Water, 100°-115°F/43°-46°C	3/4 cup + 2 TBL	1 cup + 3 TBL	1-1/2 cups + 2 TBL
Oil	2 TBL	3 TBL	1/4 cup
Salt	1 tsp	1-1/2 tsp	2 tsp
Brown Sugar	2 TBL	3 TBL	1/4 cup
Dry Milk	1 TBL	2 TBL	3 TBL
Bread Flour	2 cups	3 cups	4 cups
Cinnamon	1/2 tsp	1 tsp	1-1/2 tsp
Raisins	1/2 cup	3/4 cup	1 cup
Walnuts, chopped	1/4 cup	1/3 cup	1/2 cup
Super Rapid Type Yeast	4 tsp	5-1/4 tsp	7 tsp
Select Deluxe Super Rapid Course	9	9	9

## **DELUXE SUPER RAPID PEPPERONI PIZZA BREAD**

<b>Ingredients:</b>	<b>1.0 LB</b>	<b>1.5 LB</b>	<b>2.0 LB</b>
Water, 100°-115°F/43°-46°C	3/4 cup +2 TBL	1 cup +2 TBL	1-1/2 cups +2 TBL
Oil	1 TBL	2 TBL	3 TBL
Salt	1 tsp	1-1/2 tsp	2 tsp
Sugar	1-1/2 tsp	1 TBL	1-1/2 TBL
Pepperoni, thin julienne sliced	1/2 cup	3/4 cup	1 cup
Parmesan Cheese, grated	2 TBL	3 TBL	1/4 cup
Bread Flour	2 cups	3 cups	4 cups
Pizza Seasoning	1 tsp	2 tsp	1 TBL
Super Rapid Type Yeast	4 tsp	5-1/4 tsp	7 tsp
Select Deluxe Super Rapid Course	9	9	9



---

---

## DAY OLD BREAD RECIPES

### **BREADED PINEAPPLE**

**Ingredients:**

Chunked Pineapple	1 (15-oz) can
Cornstarch	2 TBL
Sugar	1/2 cup
Butter	1/4 cup
White Bread, 1-inch cubes	2 cups

Drain pineapple, reserve juice. Add enough water to juice to equal 1 cup. Mix cornstarch and sugar, add juice and margarine and heat until thick. Pour over pineapple and bread, toss lightly to mix. Bake at 350°F/177°C for 35 minutes.

### **BREAD PUDDING**

**Ingredients:**

Bread, 1-inch cubes	1-1/2 cups
Vanilla Cook & Serve Pudding & Pie Filling	1 (3-oz) box
Cinnamon	1 tsp
Milk, liquid	2 cups

Mix all ingredients in a microwave-safe 1-quart casserole. Cook uncovered in microwave on high for 7 minutes or until boiling—stir occasionally during the last half of cooking. Or, bake in oven at 350°F/177°C for 30 minutes—stir halfway through cooking time. Serve warm or cold.

### **CRUNCHY BREAD SNACKS**

**Ingredients:**

Bread, sliced 1/2-inch thick	8 slices
Butter, melted	1/4 cup
Dry Seasoning Mix*	4 tsp

\*Use any one of the following: dried spaghetti sauce seasoning, dry ranch dressing, Italian herb seasoning, garlic powder, or garlic salt. Amounts may be adjusted to your taste.

Melt butter and add seasoning. Place bread on baking sheet and lightly brush with butter mixture. Bake at 350°F/177°C for 10 to 15 minutes or until brown. Allow to cool breaking into bite-size pieces.



## BATTER BREADS™ COURSE RECIPES

The Batter Breads™ Course will mix and bake a pre-packaged cake mix or quick bread.

### SWEET CORN BREAD

	1 Loaf
Eggs, large, room temperature	2
Milk, 80°F/27°C	1 cup
Butter, melted	1/4 cup
Sugar	3/4 cup
Salt	1 tsp
All-Purpose Flour	2 cups
Corn Meal	1 cup
Double Acting Baking Powder	1 TBL
Select Batter Breads™ Course	10

#### Method:

1. Remove the Bread Pan from the Breadman®. Attach the Kneading Paddle onto the Shaft. Add ingredients to the Bread Pan in the order listed. Refer to MEASURING YOUR INGREDIENTS section of this Instruction Manual. Make sure all ingredients, except water, are at room temperature.
2. Place the Bread Pan into the Breadman®. Push down on the rim until it fits firmly into place. Close the Lid.
3. Press the **SELECT** Button; choose Course 10, Batter Breads™. Press the **CRUST** Button to choose crust color. If Delay Bake is desired, press the **▲ TIMER** Buttons to set the Delay Bake Timer and then press **START** for delay. (See DELAY BAKE TIMER section in this Instruction Manual) or press the **START** Button for an immediate start.

**NOTE:** *Don't use the Delay Bake Timer if your recipe includes eggs, fresh milk, yogurt, or other dairy products, meats, fish, etc. that may spoil.*

4. At the beep during the kneading process, check the dough. At this time, push down any dough or flour that may be on the sides of the Bread Pan. and, if desired, add additional ingredients (i.e., raisins, nuts, and spices). If necessary, stir ingredients during the rest time. Refer to the KNEADING AND BAKING COURSES charts in this Instruction Manual to check the Display Time that the beep will sound.
5. Before the baking begins, remove the Bread Pan from the Bread Maker. Remove the Kneading Paddle from the batter and place the Bread Pan back into the Bread Maker to complete the bake process. Removing the paddle will help prevent tearing the cake/loaf when it is removed from the pan after baking.
6. When your bread is finished baking the Breadman® will beep and "0:00" will appear in the Display Window. Press the **STOP** Button and open the Lid.





**CAUTION; THE OVEN CAVITY, BREAD PAN, KNEADING PADDLE AND BREAD WILL BE VERY HOT. USE OVEN MITTS.**

7. Remove the Bread Pan from the Breadman® as soon as the Course is complete and allow the cake or Batter Breads™ to remain in the Pan for 20 minutes on a cooling rack before removing. Using oven mitts, take a non-metal spatula and gently loosen the cake from the sides of the Pan. Turn upside down to remove. Allow to cool 15 to 30 minutes before cutting.
8. When the bread has completely cooled, approximately 1 hour, store in an air tight container.
9. UNPLUG UNIT AND ALLOW TO COOL COMPLETELY BEFORE CLEANING. Clean Bread Pan after each use, DO NOT IMMERSE THE BREAD PAN IN WATER. (See CLEANING INSTRUCTIONS outlined in this Instruction Manual.) Clean inside of Breadman® after each use.

***Batter Breads™ Course Hints for Best Results***

- It is important that you assist the Breadman® in the stirring process during the rest time. Refer to KNEADING AND BAKING Course Chart in this Instruction Manual for the appropriate time. Use a rubber spatula to gently scrape the ingredients from the sides and corners of the Pan, and fold into the wet mixture.
- A full size cake mix (16-oz or larger), quick bread or muffin mix (13-oz or larger) works well using the Batter Breads™ Course. As with any other liquid ingredients, the liquid should be 80°F/27°C and the eggs room temperature. Otherwise, add ingredients as listed on the package instructions. The 1-step angel food cake mixes may also be used. Neither a 2-step or swirl mix will work well using this program.
- Although the Delay Bake Timer is an option for this Course, our experience has shown that the recipes included do not mix well when delayed. You may find a few of your recipes may work well; therefore, we have given you delay as an option.



---

---

## ***PINEAPPLE COCONUT POUND CAKE***

### **1 Cake**

Eggs, large, room temperature	2
Crushed Pineapple, undrained	1 cup
Butter, softened	1/4 cup
Sugar	3/4 cup
Salt	1/2 tsp
Coconut, grated	1/2 cup
All-Purpose Flour	2 cups
Baking Powder	1 TBL
<hr/>	
Select Batter Breads™ Course	10

Stir, use a spatula to fold in any flour around the sides of the Bread Pan.

## ***SPICED ZUCCHINI BREAD***

### **1 Loaf**

Eggs, large, room temperature	3
Butter, softened	3/4 cup
Vanilla Extract	1-1/2 tsp
Zucchini, finely grated - unpeeled	1-1/2 cups
Sugar	1-1/2 cups
Salt	3/4 tsp
Cinnamon	3/4 tsp
All-Purpose Flour	2-2/3 cups
Pecans, chopped	3/4 cup
Baking Soda	1 tsp
Baking Powder	2 tsp
<hr/>	
Select Batter Breads™ Course	10

Stir, use a spatula to fold in any flour around the sides of the Bread Pan.



---

---

## **CHEDDAR LOAF BREAD**

	<b>1 Loaf</b>
Eggs, large, room temperature	3
Milk, 80°F/27°C	1 cup
Shortening, room temp.	1/2 cup
Cheddar Cheese, shredded	1 cup
Sugar	1/2 cup
Salt	3/4 tsp
All-Purpose Flour	2 cups
Baking Powder	1 TBL
Pecans, chopped	1/2 cup
Select Batter Breads™ Course	10

Stir, use a spatula to fold in any flour around the sides of the Bread Pan.

## **CARROT PECAN BREAD**

	<b>1 Loaf</b>
Eggs, large, room temperature	2
Milk, 80°F/27°C	2/3 cup
Butter, softened	1/4 cup
Carrots, finely grated	1-1/2 cups
Sugar	1/3 cup
Dark Brown Sugar	1/3 cup
All-Purpose Flour	2-1/4 cups
Salt	1/2 tsp
Cinnamon	3/4 tsp
Nutmeg	1/4 tsp
Pecans, chopped	3/4 cup
Baking Powder	1 TBL
Select Batter Breads™ Course	10

Stir, use a spatula to fold in any flour around the sides of the Bread Pan.



## BANANA NUT CAKE

	1 Cake
Whole Eggs, large, room temperature	2
Egg Whites, room temperature	2
Sour Milk	1/3 cup
Banana, mashed	1-1/2 cups
Oil	6 TBL
Sugar	1 cup
Salt	3/4 tsp
Cream of Tartar	1-1/2 tsp
All-Purpose Flour	2 cups
Nuts, chopped	3/4 cup
Baking Soda	3/4 tsp
Baking Powder	2 tsp
Select Batter Breads™ Course	10

Stir, use a spatula to fold in any flour around the sides of the Bread Pan.



## BREAD / PIZZA / PASTA DOUGH COURSES

### *Dough Courses Method:*

1. Add ingredients to the Bread Pan in the order listed. Refer to MEASURING YOUR INGREDIENTS section of this Instruction Manual. Place the Bread Pan into the Breadman®. Push down on the rim until it fits firmly into place. Close the Lid.
2. Press the **SELECT** Button; choose Course 11, 12 or 14: Bread Dough, Pizza Dough or Pasta Dough. Press the **LOAF** Button to choose loaf size. If Delay Bake is desired, press the **▲ TIMER** Buttons to set the Delay Bake Timer and then press **START** for delay. (See DELAY BAKE TIMER section in this Instruction Manual) or press the **START** Button for an immediate start.

**NOTE:** Don't use the Delay Bake Timer if your recipe includes eggs, fresh milk, yogurt, or other dairy products, meats, fish, etc. that may spoil.

3. When your dough is finished, the Breadman® will beep and "0:00" will appear in the Display Window. Press the **STOP** Button and open the Lid. Remove the dough from the Bread Pan. Follow recipe shaping and baking instructions.

### *Dough Course Hints for Best Results*

- If using Delay Bake Timer, make sure yeast is on top of flour, away from liquids.

### **IMPORTANT:**

- Never allow the dough to remain in the Bread Maker after the Course is complete; it may over rise and damage the machine.
- Rising times for dough after it is shaped and placed in a baking pan will vary due to recipe, temperature and humidity level of your kitchen. The optimum temperature of the room for rising is 80°-85°F/27°-29°C. Rising is the most essential feature in bread making.
- The Bread Maker allows the dough to have a first rise or fermentation before the dough is removed. Fermentation conditions the gluten, (becoming pliable and elastic with a soft, smooth quality) develops the flavor and leavens the product.
- Sometimes a double rising is beneficial especially for whole grain or 100% whole wheat bread. Let the dough rise once in Bread Maker. Remove from Bread Maker, punch down, let rise again, punch down and let rest 10 minutes. Resting allows the gluten to relax and makes handling easier. Shape as desired and allow to rise until doubled in volume. If only 1 rise is desired, remove from Bread Maker, let rest, shape and rise as above.

### **BAKER'S HINT:**

- Dough has doubled in volume when an indentation remains after the tip of a finger is pressed lightly and quickly into the dough. If the indentation springs back, cover and let rise a few more minutes and check again.



## MAKING DOUGHS: CRUST TREATMENTS

### *(For use only with the Dough Courses)*

- Always allow optimum rising of shaped dough.
- Use a pastry brush to apply glaze.
- Bake as directed.

### *Egg Yolk Glaze*

For a shiny golden crust, mix 1 slightly beaten egg or egg yolk with 1 TBL water or milk.

### *Egg White Glaze*

For a shiny, chewy crust, mix 1 slightly beaten egg white with 1 TBL water.

### *Lightly Floured*

Sprinkle enough flour onto work area so that the dough can be handled without sticking.

### *Shaped Rolls:*

#### *Cloverleaf Rolls*

Shape into 1/2-inch balls. Place 3 balls in each muffin tin and let rise until doubled in size.

#### *Crisscross Rolls*

Shape into balls setting 2 aside. Combine the balls and roll into a 1/8-inch thick square. Cut strips 1/8-inch wide and 2-inches long. Place 1 strip across the top of each ball. Repeat this process placing the second strip in the opposite direction across the top of each ball.

#### *Traditional Rolls*

Shape into balls. For “pull apart” rolls, place dough balls with sides touching. For “individual” rolls place dough balls 2-inches apart.



## DOUGH COURSE RECIPES

### *DINNER ROLL DOUGH*

<b>Ingredients:</b>	<b>12 Rolls</b>	<b>18 Rolls</b>	<b>24 Rolls</b>
Egg, large, room temperature plus enough Water, 80°F/27°C to equal	1	1	1
Oil	3/4 cup	3/4 cup + 1 TBL	1-1/3 cups
Sugar	2 TBL	3 TBL	1/4 cup
Salt	2 TBL	3 TBL	1/4 cup
Bread Flour	1 tsp	1-1/2 tsp	2 tsp
Active Dry Yeast	2 cups	3 -1/4 cups	4 cups
	1-1/2 tsp	2 tsp	2-1/4 tsp
Select Dough Course	11	11	11

#### **Method:**

1. Place on a lightly floured surface. Divide into pieces and shape.
2. Place on a greased baking sheet. Cover and let rise in a warm place for 30 minutes or until doubled in size.
3. Bake at 350°F/177°C for 15 to 25 minutes, or until golden brown.



## WHEAT DINNER ROLL DOUGH

<b>Ingredients:</b>	<b>9 Rolls</b>	<b>18 Rolls</b>
Water, 80°F/27°C	3/4 cup	1-1/2 cups
Oil	1 TBL	2 TBL
Brown Sugar	2 TBL	1/4 cup
Salt	1 tsp	2 tsp
Dry Milk	1 TBL	2 TBL
Bread Flour	1-1/4 cups	2-1/2 cups
Whole Wheat Flour	1 cup	2 cups
Active Dry Yeast	2 tsp	2-1/4 tsp
Select Dough Course	11	11

### **Method:**

1. Place on a lightly floured surface. Divide into pieces and shape.
2. Place on a greased baking sheet. Cover and let rise in a warm place for 30 minutes or until doubled in size.
3. Bake at 350°F/177°C for 25 to 30 minutes, or until golden brown.





## BUTTERMILK ROLL DOUGH

<b>Ingredients:</b>	<b>9 Rolls</b>	<b>12 Rolls</b>
Cultured Buttermilk, 80°F/27°C	3/4 cup	1 cup
Oil	3 TBL	1/4 cup
Honey	1-1/2 TBL	2 TBL
Salt	1 tsp	1-1/2 tsp
Bread Flour	2 cups	3 cups
Wheat Germ	1/3 cup	1/2 cup
Baking Soda	1/4 tsp	1/4 tsp
Active Dry Yeast	1-1/2 tsp	2 tsp
Select Dough Course	11	11
Butter, melted	2 TBL	3 TBL

### **Method:**

1. Place on a lightly floured surface. Divide into pieces and shape.
2. Place on a greased baking sheet. Cover and let rise in a warm place for 30 minutes or until doubled in size. Brush with melted butter.
3. Bake at 350°F/177°C for 15 to 20 minutes, or until golden brown.
4. Brush melted butter onto the tops of rolls.



## CHEEZY GARLIC ROLL DOUGH

<b>Ingredients:</b>	<b>12 Rolls</b>	<b>18 Rolls</b>
Egg, large, room temperature plus enough Water, 80°F/27°C to equal	1	1
Oil	1 cup	1-1/2 cups
Sugar	2 TBL	3 TBL
Salt	1/3 cup	1/2 cup
Dry Milk	1-1/2 tsp	2 tsp
Bread Flour	1 TBL	2 TBL
Active Dry Yeast	3-1/2 cups	4-1/2 cups
	2 tsp	2-1/4 tsp
Select Dough Course	11	11
<b>Topping:</b>		
Parmesan Cheese, grated	1/2 cup	2/3 cup
Garlic, finely minced	1-1/2 TBL	2 TBL
Butter, melted	3 TBL	1/4 cup

### **Method:**

1. Place on a lightly floured surface. Divide into pieces and shape.
2. Combine cheese and garlic. Dip pieces in melted butter and then in cheese-garlic mixture. Place in greased 9-inch x 13-inch baking dish. Cover and let rise in a warm place for 45 minutes or until doubled in size.
3. Bake at 325°F/163°C for 35 to 40 minutes, or until golden brown.



## REFRESHING ROLL DOUGH

<b>Ingredients:</b>	<b>12 Rolls</b>	<b>18 Rolls</b>
Egg, large, room temperature plus enough Water, 80°F/27°C to equal	1	1
Butter	1 cup	1-1/2 cups
Brown Sugar	1/4 cup	1/3 cup
Salt	1/3 cup	1/2 cup
Bread Flour	1-1/2 tsp	2 tsp
Active Dry Yeast	3-1/2 cups	4-1/2 cups
	2 tsp	2-1/4 tsp
Select Dough Course	11	11
<b>Topping:</b>		
Butter, melted	1/2 cup	3/4 cup
Orange Peel, grated	2 TBL	1/4 cup
Sugar	1/2 cup	3/4 cup

### **Method:**

1. Place on a lightly floured surface. Divide into pieces and shape.
2. Mix together topping ingredients, dip pieces in mixture coating well.
3. Place in greased 9-inch x 13-inch baking dish. Cover and let rise in a warm place for 30 minutes or until doubled in size. Brush with melted butter.
4. Bake at 350°F/177°C for 20 to 30 minutes, or until golden brown. Serve warm.



## CINNAMON ROLL DOUGH

<b>Ingredients:</b>	<b>12 Rolls</b>
Egg, large, room temperature plus enough Water, 80°F/27°C to equal	1
Oil	1 cup
Sugar	3 TBL
Salt	1/3 cup
Bread Flour	1-1/2 tsp
Active Dry Yeast	3-1/2 cups
	2 tsp
Select Dough Course	11

<b>Filling:</b>	
Butter, melted	1/3 cup
Sugar	1/4 cup
Cinnamon	2 TBL
Walnuts, finely chopped	1/4 cup
Raisins	1/4 cup

<b>Glaze:</b>	
Powdered Sugar	1/2 cup
Milk, liquid	3 TBL
Vanilla Extract	1/2 tsp

### **Method:**

1. Place on a lightly floured surface, roll dough into a 12-inch x 6 inch rectangle and spread with butter. Combine remaining filling ingredients and sprinkle over butter. Roll up tightly, jelly-roll style, starting with the longest side and cut into 1-inch slices.
2. Place on a greased baking pan, about 1/2-inch apart and let stand in a warm place for 30 minutes or until doubled in size.
3. Bake at 350°F/177°C for 25 to 30 minutes, or until golden brown.
4. Mix glaze ingredients until smooth and drizzle over top.



## STICKY BREAKFAST BUN DOUGH

<b>Ingredients:</b>	<b>12 Buns</b>
Egg, large, room temperature plus enough Water, 80°F/27°C to equal	1 <hr/> 1 cup
Oil	3-1/2 tsp
Sugar	1/3 cup
Salt	1-1/2 tsp
Bread Flour	3-1/2 cups
Active Dry Yeast	2 tsp
<hr/>	
Select Dough Course	11
<hr/>	
<b>Filling:</b>	
Butter, softened	1/2 cup
Sugar	1/3 cup
Cinnamon	1 TBL
Pecans, chopped	1/2 cup
<hr/>	
<b>Topping:</b>	
Butter, melted	3/4 cup
Brown Sugar	3/4 cup
<hr/>	
Pecan Halves (optional)	1 cup

### **Method:**

1. Place on a lightly floured surface, roll dough into a 12-inch x 16 inch rectangle and spread with butter. Combine remaining filling ingredients and sprinkle over dough. Roll up tightly, jelly-roll style, starting with the longest side and cut into 1-inch slices.
2. Combine topping mixture and spread into a 13-inch x 9-inch baking dish. If you are using optional pecan halves, line the bottom of the pan. Place slices on mixture and let rise in a warm place for 30 minutes or until doubled in size.
3. Bake at 350°F/177°C for 35 minutes, or until golden brown. Use oven mitts to carefully invert onto a heat-proof tray; syrup will be very hot.



---

---

## BRIOCHE ROLL DOUGH

<b>Ingredients:</b>	<b>18 Rolls</b>
Water, 80°F/27°C	1 cup
Egg Yolks	6
Butter, cold, chipped into pieces	6 TBL
Salt	1-1/2 tsp
Sugar	6 TBL
Dry Milk	3 TBL
Vanilla Extract	1/4 tsp
Bread Flour	3 cups
Active Dry Yeast	2-1/4 tsp
<hr/>	
Select Dough Course	11

---

### **Glaze:**

Whisk together 2 egg yolks and 1 tablespoon water.

---

### **Method:**

1. Remove dough from Bread Pan and punch down to remove any air bubbles. Divide dough into 3 equal sections. Divide each section into 6 pieces. Make each piece into a brioche by dividing into a large and small ball. Roll to make round and place large ball in a greased brioche or muffin cup.
2. Dip smaller ball into glaze and then place on top of larger ball. Allow to rise until indentation remains after gently touching the side of the roll. Brush the rolls with glaze.
3. Bake at 350°F/177°C for 10 to 15 minutes until golden brown.



## FRENCH BREAD DOUGH

<i>Ingredients:</i>	<i>1 Loaf</i>
Water, 80°F/27°C	1 cup
Sugar	1 TBL
Salt	1-1/2 tsp
Bread Flour	3-1/2 cups
Active Dry Yeast	2 tsp
Select Dough Course	11

### *Glaze:*

Water	2 TBL
Salt	1/2 tsp

**Method 1:** Place on a lightly floured surface. Roll into a large rectangle. Starting with the longest side, roll up tightly, pressing the seams to seal and tapering each end.

**Method 2:** Place the loaf on a greased baking sheet, cover and let rise in a warm place 40 minutes or until doubled in size.

**Method 3:** With a knife, cut 3 diagonal slashes across top of the loaf. Combine the glaze ingredients and brush the loaf generously. Bake at 400°F/205°C for 20 to 25 minutes until golden brown.

### *Variations:*

**French Onion Bread:** Add 1/4 cup dehydrated onion to dough and shape according Method 1 described above.

**French Loaf:** Shape the dough into 1 large round ball. Continue Methods 2 and 3 above.

**French Roll:** Shape or divide into 12 pieces. Roll each into ovals, pinch together the ends of each roll and taper slightly. Place rolls on greased baking sheet; cover and let rise in a warm place 25 to 30 minutes or until doubled in size. Bake at 400°F/205°C for 15 to 20 minutes or until golden brown.

**French Twists:** Shape or divide into 12 equal pieces. Roll into 14-inch long ropes. Fold each rope in half and twist, starting at fold. Place on greased baking sheet and brush with 1/3 cup melted butter. Cover and let rise in a warm place 25 to 30 minutes or until doubled in size. Brush with glaze and bake at 400°F/205°C for 12 to 15 minutes or until golden brown.

**Tip:** If desired, brush with glaze and sprinkle loaves or rolls before baking with 1 of the following: sesame seeds, poppy seeds, caraway seeds, or cracked wheat.



## CHALLAH BREAD DOUGH

<b>Ingredients:</b>	<b>Regular</b>	<b>Large</b>
Egg, large, room temperature plus enough Water, 80°F/27°C to equal	1	1
Oil	3/4 cup	1 cup + 1 TBL
Sugar	2 TBL	3 TBL
Salt	1-1/2 TBL	2 TBL
Bread Flour	1 tsp	1-1/2 tsp
Active Dry Yeast	2 cups	3-1/4 cups
	1-1/2 tsp	2 tsp
Select Dough Course	11	11
<b>Glaze:</b>		
Egg Yolk, beaten	1	1
Water	1 TBL	1 TBL
<b>Topping:</b>		
Poppy Seeds	1 tsp	1 TBL

### **Method:**

1. Place dough on a lightly floured surface. Divide into thirds, making 3 (10-inch regular, 13-inch large) ropes with tapered ends. Pinch ropes together at 1 end, braid together. Pinch together at other end and secure braid.
2. Transfer braided dough to greased baking sheet; cover and let rise in a warm place for 45 minutes or until doubled in size.
3. Combine glaze ingredients and brush onto braid. Sprinkle with poppy seeds. Bake at 375°F/190°C for 25 minutes or until golden brown.





## CREAMED SOUP BREAD BOWL DOUGH

<b>Ingredients:</b>	<b>4 Bowls</b>
Egg, large, room temperature plus enough Water, 80°F/27°C to equal	2 1 cup + 5 TBL
Oil	2 TBL
Honey	1/4 cup
Dry Milk	3 TBL
Salt	2 tsp
Bread Flour	2-1/4 cups
Whole Wheat Flour	1 cup
Rye Flour	1 cup
Caraway Seeds	3 TBL
Dehydrated Onions	1/4 cup
Active Dry Yeast	2 tsp
Select Dough Course	11

**NOTE:** Any 2.0 LB. bread or dough recipe may be used; mix on Dough program.

### **Method:**

1. Place dough on a lightly floured surface and divide into 4 equal pieces. Shape into 4 smooth round balls and place on a greased baking sheet.
2. Cover and let rise in a warm place for 1 hour or until doubled in size.
3. Bake at 350°F/177°C for 25 to 30 minutes or until golden brown. Allow to cool completely on a wire rack.
4. With a serrated knife, remove the top 1-inch of each bread bowl. Remove the center, leaving a shell of 1/2-inch on sides and bottom.
5. Fill with approximately 1 cup of creamed soup \*(non-creamed soup will soak through the bread bowl too easily).

\*Chili and stew work well in bread bowls.



## PARTY DIP BREAD BOWL

<b>Ingredients:</b>	<b>1 Bowl</b>
Water, 80°F/27°C	1-1/4 cups
Sugar	1 TBL
Salt	1-1/2 tsp
Bread Flour	3-1/2 cups
Active Dry Yeast	2 tsp
Select Dough Course	11

**NOTE:** Any 1.5 LB bread or dough recipe may be used; mix using the Dough Course.

### Method:

1. Place dough on a lightly floured surface. Shape into smooth round balls and place on a greased baking sheet.
2. Cover and let dough rise in a warm place for 1 hour or until doubled in size.
3. Bake at 350°F/177°C for 30 to 40 minutes or until golden brown. Allow to cool completely on a wire rack.
4. With a serrated knife, remove the top 1-inch of bread bowl. Remove the center, leaving a shell of 1/2-inch on sides and bottom.
5. Fill with 3 cups of Party Dip. Cut removed bread into 1-inch pieces and serve with dip.

### Shredded Beef Dip

**Ingredients:** 3 Cups

Dried Beef, chopped	5 oz
Cream Cheese, softened	2 (8-oz) pkg
Sour Cream	1/2 cup
Green Onions, chopped	6
Accent® Seasoning	2-1/2 tsp
Worcestershire Sauce	to taste

Mix and chill before serving.

### Shrimp Dip

**Ingredients:** 3 Cups

Canned Shrimp, drained and mashed	2 small cans
Cream Cheese, softened	1 (8-oz) pkg
Mayonnaise	1 cup
Green Onions, chopped	3

Mix and chill before serving.



## ALMOND-CHERRY COFFEE CAKE DOUGH

<b>Ingredients:</b>	<b>1 Coffee Cake</b>
Water, 80°F/27°C	1 cup
Oil	1 TBL
Sugar	1-1/2 TBL
Salt	1-1/2 tsp
Dry Milk	1 TBL
Bread Flour	3 -1/4 cups
Active Dry Yeast	2 tsp
Select Dough Course	11

### **Filling:**

Cream Cheese, room temperature	8 oz
Sugar	2 TBL
Maraschino Cherries, drained, chopped	1/2 cup
Milk, liquid	1 TBL
Almond Extract	1/2 tsp

### **Glaze:**

Powdered Sugar	1/2 cup
Sour Cream	1 TBL
Milk, liquid	1 - 2 TBL
Almonds, sliced	2 TBL
Cherries	2 TBL

### **Method:**

1. Place on a lightly floured surface. Roll into a 15-inch x 10-inch rectangle. Spread filling over dough within 1/2-inch of edges. Starting with longest side, roll dough up tightly, pressing edges to seal.
2. Place roll, seam-side down, on a greased baking sheet and join the ends to form a ring; pinch to seal. With a knife, make cuts 1-1/2-inches apart from the outside edge to within 1-inch of the inside edge. Turn each section on its side so filling shows.
3. Cover and let rise in a warm place 40 minutes or until almost doubled in size.
4. Uncover and bake at 375°F/190°C for 20 to 25 minutes or until golden brown.
5. Combine the first 3 glaze ingredients, adding only enough milk for drizzling consistency. Drizzle over the warm coffee cake. Decorate with almonds and cherries. Serve warm.



## BAGEL DOUGH

<b>Ingredients:</b>	<b>8 Bagels</b>
Water, 80°F/27°C	1 cup
Sugar	1-1/2 TBL
Salt	1-1/2 tsp
Bread Flour	3 cups
Active Dry Yeast	2 tsp
<hr/>	
Select Dough Course	11

### **Glaze:**

Egg, beaten

### **Toppings (optional):**

Sesame Seeds, poppy seeds, cracked wheat dry cereal, or dehydrated onions

### **Method:**

1. Place on a lightly floured surface. Divide into pieces. Roll each in a smooth ball, making a hole in the center of each with thumbs. Gently pull to make a 1-inch hole.
2. Place on a greased baking sheet. Cover and let rise in a warm place for 10 minutes.
3. In a 3-quart sauce pan, bring to a boil 2 quarts of water and 2 tablespoons sugar. Place a few bagels at a time in boiling water. Simmer 3 minutes, turning each bagel once. Remove with slotted spoon and put back on greased baking sheet.
4. Brush with egg and sprinkle with choice of toppings. Bake at 400°F/204°C for 20 to 25 minutes or until done; cool on a wire rack.



---

---

## BANANA WHEAT BAGEL DOUGH

<b>Ingredients:</b>	<b>12 Bagels</b>
Egg, large, room temperature plus enough Water, 80°F/27°C to equal	1 1 cup
Oil	2 TBL
Honey	1 TBL
Salt	1-1/2 tsp
Banana, mashed	1/2 cup
Whole Wheat Flour	2-1/2 cups
Bread Flour	1 cup
Active Dry Yeast	2 tsp
Select Dough Course	11
<b>Glaze:</b>	
Egg White, beaten	1
Water	1 TBL
<b>Toppings</b> (optional):	
Poppy Seeds, Sesame Seeds	

### **Method:**

1. Place on a lightly floured surface. Divide into pieces. Roll each in a smooth ball, making a hole in the center of each with thumbs. Gently pull to make a 1-inch hole.
2. Place on a greased baking sheet. Cover and let rise in a warm place for 10 minutes.
3. In a 3-quart sauce pan, bring to a boil 2 quarts of water and 2 tablespoons sugar. Place a few bagels at a time in boiling water. Simmer 3 minutes, turning each bagel once. Remove with slotted spoon and put back on greased baking sheet.
4. Brush with egg white and sprinkle with choice of toppings. Bake at 400°F/204°C for 20 to 25 minutes or until done; cool on a wire rack.



## EGG BAGELS

<i>Ingredients:</i>	<i>12 Bagels</i>
Water, 80°F/27°C	3/4 cup
Egg	1
Salt	1-1/2 tsp
Sugar	2 TBL
Bread Flour	3 cups
Active Dry Yeast	2 tsp
Select Dough Course	11

### **Method:**

1. When Course is complete, remove the dough onto lightly floured surface. Punch down to remove air bubbles. Divide dough into 4 parts and then divide each part into 3 pieces. Shape each piece into a smooth ball with finger, punch hole in center. Pull dough gently to make a 1 to 2-inch hole. Let rise 20 minutes.
2. Meanwhile, heat 2 quarts water and 2 tablespoons sugar to boiling. Place a few bagels at a time in boiling water. Simmer 3 minutes, turning each bagel once. Remove with a slotted spoon.
3. Place on greased cookie sheet. Brush with 1 slightly beaten egg white; sprinkle with poppy or sesame seeds.
4. Bake in preheated 374°F/190°C oven 20 to 25 minutes or until golden brown. Remove from cookie sheet and cool.



## SOFT PRETZEL DOUGH

<b>Ingredients:</b>	<b>16 Pretzels</b>
Water, 80°F/27°C	1-1/4 cups
Egg Yolk, room temperature	1
Oil	1 TBL
Sugar	2 TBL
Salt	1-1/2 tsp
White Pepper	1/8 tsp
Bread Flour	3-1/2 cups
Active Dry Yeast	2-1/4 tsp

Select Dough Course	11
---------------------	----

<b>Glaze:</b>	
Egg White	1
Water	1 TBL

**Toppings:** (optional):  
Kosher salt, sesame seeds

### **Method:**

1. On a lightly floured surface cut dough into pieces. Roll each piece into a 16-inch rope. Cross the ends of the rope to make a loop; twist the crossed ends once and fold across the loop.
2. Place on a greased baking sheet 1-1/2-inches apart. Brush with glaze and sprinkle with topping. Bake at 375°F/190°C for 15 to 20 minutes or until golden brown.

### **Variation:**

Pepperoni Pretzel: Add 1 cup sliced pepperoni and 2 tablespoons Parmesan cheese to dough ingredients. Follow method of completion.



## PITA POCKET DOUGH

<b>Ingredients:</b>	<b>20 Pita Pockets</b>
Water, 80°F/27°C	1-1/3 cups
Olive Oil	8 tsp
Sugar	4 tsp
Salt	1-1/2 tsp
Bread Flour	2 cups
Whole Wheat Flour	1-1/3 cups
Active Dry Yeast	2 tsp
Select Dough Course	11

### **Method:**

1. Place on a lightly floured surface. Divide into 10 pieces. Shape each piece into a smooth ball.
2. Place 5 balls on a large baking sheet. Place the remaining 5 balls on another baking sheet. Let rise about 20 minutes. With fingertips, flatten each ball into a 6-inch circle.
3. Bake at 500°F/260°C for 5 minutes or until puffed and tops begin to brown.
4. Cut each in half to form 2 pockets.





## PIZZA DOUGH RECIPES

### PIZZA CRUST DOUGH

<b>Ingredients:</b>	<b>1 Thick or 2 Thin Crusts</b>	<b>2 Thick or 4 Thin Crusts</b>
Water, 80°F/27°C	3/4 cup	1-2/3 cups
Oil	1 TBL	2 TBL
Sugar	1 TBL	2 TBL
Salt	1-1/2 tsp	2 tsp
Dry Milk	1 TBL	2 TBL
Bread Flour	2-1/4 cups	4-1/2 cups
Active Dry Yeast	1 tsp	2 tsp
Select Pizza Dough Course	12	12

#### **Method:**

1. Place on a lightly floured surface. Divide and press onto a 12-inch pizza Pan, raising edges.
2. Spread pizza sauce over the dough and sprinkle with toppings.
3. Bake at 425°F/218°C for 20 minutes or until crust is golden brown around edges.

### WHOLE WHEAT PIZZA CRUST DOUGH

<b>Ingredients:</b>	<b>2 Thin Crusts</b>
Water, 80°F/27°C	1 cup
Oil	2 TBL
Sugar	1 TBL
Salt	1 tsp
Whole Wheat Flour	1 cup
Bread Flour	1-1/2 cups
Active Dry Yeast	1 tsp
Select Pizza Dough Course	12

#### **Method:**

1. Place finished dough on a lightly floured surface. Divide in half and press onto a 12-inch pizza pan, raising edges. (Sprinkle each Pan with 1 tablespoon of cornmeal if desired.) Generously prick dough with a fork. For 1 (12-inch thick) crust, do not divide.
2. Bake at 425°F/218°C for 10 to 12 minutes or until edges of crust begin to turn a light golden brown. Remove, add toppings and return to oven to bake an additional 15 to 20 minutes.



## RUSTIC PIZZA MARGHERITA

<b>Ingredients:</b>	<b>2 Thin Crusts</b>
Water, 80°F/27°C	1 cup + 2 TBL
Olive Oil	1-1/2 TBL
Salt	1-1/2 tsp
Sugar	1-1/2 tsp
Bread Flour	3 cups
Active Dry Yeast	1-1/2 tsp
Select Pizza Dough Course	12

<b>Topping</b>	<b>1 Pizza</b>	<b>2 Pizzas</b>
Corn Meal	2 tsp	4 tsp
Olive Oil	1 TBL	2 TBL
Tomatoes, large <i>or</i> Roma Tomatoes, large, thinly sliced	2 4	4 8
Basil Leaves, fresh, shredded	1/4 cup	1/2 cup
Salt	1/4 tsp	1/2 tsp
Black Pepper, freshly ground <i>or</i> Red Pepper Flakes, ground	1/8 tsp	1/4 tsp
Mozzarella Cheese,* fresh <i>or</i> Fontina Cheese, torn	1 cup	2 cups
Parmesan Cheese, grated	1/4 cup	1/2 cup

### **Method:**

1. Sprinkle pizza pan(s) or cookie sheets evenly with corn meal. Place dough on lightly floured surface, divide in half and press into two 14-inch pizza pan(s).
2. Brush dough evenly with olive oil. Top with tomatoes and basil; sprinkle lightly with salt and black pepper or red pepper flakes. Top with both cheeses.
3. Bake at 425°F/218°C for 18 to 20 minutes or until edges of crust are golden brown.

### **Variation:**

Use goat cheese or feta cheese.

If you can not find fresh mozzarella, use standard mozzarella.



## FOCACCIA DOUGH

<b>Ingredients:</b>	<b>1 Loaf</b>
Water, 80°F/27°C	1 cup
Olive Oil	1/3 cup
Sugar	2 tsp
Salt	1-1/2 tsp
Bread Flour	3 cups
Dried Italian Seasoning	1 tsp
Active Dry Yeast	2 tsp
Select Pizza Dough Course	12

### **Garlic-Cheese Topping:**

Olive Oil	1/4 cup
Dried Oregano	1-1/2 tsp
Garlic, finely minced	1/4 cup
Parmesan Cheese, grated	1/3 cup
Salt	1/4 tsp

### **Greek-Style Topping:**

Olive Oil	1/4 cup
Dried Oregano	1-1/2 tsp
Onion, thinly sliced	1 cup
Feta Cheese, crumbled	1/3 cup
Black Olives, sliced - drained	1/4 cup
Salt	1/4 tsp

### **Method:**

1. With oiled hands, evenly press dough into a greased 9-inch x 13-inch Pan . Using your fingertips, make indentations in the dough.
2. Cover, let rise in a warm place for 20 minutes or until doubled in size. While the dough is rising, select the topping and prepare.
3. In a skillet, heat oil. For Garlic-cheese topping-stir in oregano and garlic- immediately remove from heat. For Greek topping-stir in oregano and onions-cook until onions are soft but not brown (approximately 5 minutes).
4. Spoon topping mixture evenly over dough. Sprinkle with remaining ingredients.
5. Bake at 400°F/205°C for 20 minutes or until golden brown.



## PASTA DOUGH RECIPES

The Pasta Dough Course allows you the versatility to prepare many types of dough for your baking enjoyment. Here you will find not only Pasta Dough but cookies, pie crust and dumplings to get you started.

### BASIC PASTA DOUGH

<b>Ingredients:</b>	<b>1.0 LB</b>	<b>2.0 LB</b>
Milk, 80°F/27°C	3/4 cup	1-1/2 cups
Oil	6 TBL	3/4 cup
Salt	3/4 tsp	1-1/2 tsp
Semolina (Pasta) Flour	2 cups	4 cups
Select Pasta Course	14	14
Cooked Pasta	5 cups	10 cups

#### **Method:**

1. Removes the bread pan from the Breadman®. Attach the Kneading Paddle onto the Drive Shaft. Have all ingredients ready. Make sure all ingredients, except milk (80°F/27°C), are at room temperature.
2. Use a liquid measuring cup to measure the milk and pour into Bread Pan.
3. Use a measuring spoon to measure the oil and add to Bread Pan.
4. Use a measuring spoon to measure salt; level off with the straight edge of a knife and add to the Bread Pan.
5. Lightly spoon semolina (pasta) flour into a dry measuring cup, level off with the straight edge of a knife and add to Bread Pan.
6. Place the Bread Pan into the Breadman®. Push down on the rim until it fits firmly into place. Close Lid.
7. Press the **SELECT** Button; choose Course 14, Pasta Dough. Press the **START** Button.
8. At the beep, during the kneading process, check the dough ball. It will be slightly sticky to the touch. At this time, push down any dough or flour that may be on the sides of Bread Pan. Refer to the **KNEADING AND BAKING COURSE CHART** in this Instruction Manual to check the Display Time that the beep will sound.
9. The beeper will sound when the dough has finished mixing and “0:00” will appear in the Display Window. Press the **STOP** Button and remove the dough from the Bread Pan.
10. Using a rolling pin, on a lightly-floured surface, roll out dough to about 1/8-inch thickness. Cut dough into strips about 1/2-inch wide.



11. Use 6 cups of boiling water for 1.0 LB of dough and cook for 10 to 15 minutes or until tender. DO NOT OVER COOK. Drain well.
12. Use in any of your favorite pasta recipes.
13. UNPLUG UNIT AND ALLOW TO COOL COMPLETELY BEFORE CLEANING. Clean Bread Pan after each use; DO NOT IMMERSE THE BREAD PAN IN WATER. (See CLEANING INSTRUCTIONS outlined in this Instruction Manual.) Clean inside of Breadman® after each use.

## EGG PASTA DOUGH

<b>Ingredients:</b>	<b>1.5 LB</b>	<b>2.0 LB</b>
Water, 80°F/27°C	1/2 cup + 1 TBL	3/4 cup + 1 TBL
Eggs, large, room temperature	3	4
Oil	1 TBL	1-1/2 TBL
Salt	1 tsp	1-1/2 tsp
Semolina Flour	1 cup	1-1/2 cups
All-Purpose Flour	2 cups	2-1/2 cups
Select Pasta Dough Course	14	14
<b>Yield:</b> Cooked Pasta	8 cups	10 cups

## SPINACH PASTA DOUGH

<b>Ingredients:</b>	<b>1.5 LB</b>	<b>2.0 LB</b>
Water, 80°F/27°C	3/4 cup + 2 TBL	1 cup + 1 TBL
Oil	1 TBL	1-1/2 TBL
Salt	1 tsp	1-1/2 tsp
Semolina Flour	1 cup	1-1/2 cups
All-Purpose Flour	2 cups	2-1/2 cups
Spinach, finely chopped, 10-oz frozen package, cooked	1	1
OR 14-oz can well-drained		
Select Pasta Dough Course	14	14
<b>Yield:</b> Cooked Pasta	8 cups	10 cups

**NOTE:** Both recipes will use the same amount of spinach.



---

---

## DUMPLINGS

<b>Ingredients:</b>	<b>4 servings</b>
Milk, 80°F/27°C	1 cup
Oil	1/2 cup
Salt	1/4 tsp
All-Purpose Flour	2-2/3 cups
Baking Powder	4 tsp
Select Pasta Dough Course	14

### **Method:**

1. When beeper sounds on Breadman®, remove dough from Bread Pan. Place in a bowl.
2. Using a teaspoon, carefully drop dumplings into 6 cups of boiling broth.
3. Lower heat to medium and cook for 10-15 minutes or until tender. **DO NOT OVER COOK**

## PIE CRUST

<b>Ingredients:</b>	<b>2 crusts</b>
Water, cold, 40°F/4°C	1/2 cup
Shortening or Butter, cold	3/4 cup
Salt	1/2 tsp
All-Purpose Flour	2-1/2 cups
Select Pasta Dough Course	14

**NOTE:** For flaky crusts, have ingredients as cold as possible.

### **Method:**

1. When the beeper sounds on Breadman®, remove dough from Bread Pan.
2. Divide dough in half; roll each half out on a lightly floured surface.
3. **For baked pie crust:** Place crust in pie pan, crimp edges, and prick with a fork. (You may want to weigh the crust down with dry beans or pie weights. Line crust with foil and weights)
4. Bake at 425°F/218°C for 20 minutes or until golden brown. Fill crust as desired.
5. **For fruit or other 2-crust pies:** Place 1 crust in pie pan, fill with desired filling and top with second crust. Crimp edges to seal. Cut steam vents in top crust.
6. Bake as required for your filled pie.



## COOKIE DOUGH RECIPES

### AMARETTO RAISIN COOKIES

<b>Ingredients:</b>	<b>2 dozen</b>
Amaretto Liquor or Vanilla Extract	1 TBL
Eggs, large, room temperature	2
Butter, softened	1 cup
Brown Sugar, packed	3/4 cup
Raisins	3/4 cup
All-Purpose Flour	2-1/2 cups
Baking Powder	1-1/2 tsp
<hr/>	
Select Pasta Dough Course	14

#### *Method for Cookies:*

1. Press the **SELECT** Button; Choose Course 14, Pasta Dough. Press **START**.
2. When the beeper sounds on Breadman®, remove the dough from the Bread Pan. Drop by rounded tablespoons on to a lightly greased or papered cookie sheet.
3. Bake at 350°F/177°C for 12 to 15 minutes or until golden brown.

### OATMEAL RAISIN COOKIES

<b>Ingredients:</b>	<b>2-1/2 dozen</b>
Eggs, large, room temperature	2
Butter, melted	1 cup
Brown Sugar, packed	1 cup
Sugar	1/2 cup
All-Purpose Flour	1-1/2 cups
Cinnamon	1 tsp
Salt	1/2 tsp
Quick or Old-Fashioned Oats (like Quaker®)	3 cups
Raisins	1 cup
Baking Soda	1 tsp
<hr/>	
Select Pasta Dough Course	14



## JAM COURSE METHOD AND RECIPES...AS EASY AS 1-2-3

### *Jam Course Method:*

1. Remove the Bread Pan from the Breadman®. Attach the Kneading Paddle onto the Drive Shaft. Have all ingredients ready. Clean fresh berries or fruit, cut into 1/2-inch cubes. Drain fruit before crushing.
2. Use a liquid measuring cup to measure the drained, crushed fruit.
3. Use a dry measuring cup to measure the sugar.
4. Use a measuring spoon to measure the lemon juice, if using.
5. Place the Bread Pan into the Breadman®. Push down until it fits firmly into place. Close Lid.
6. Press the **SELECT** Button; Choose Course 13, Jam. Press **START**.
7. The Bread Maker will pre-heat for 15 minutes before any movement occurs in the Bread Pan. After pre-heating, the jam will be heated and mixed for approximately 50 minutes. The entire Jam Course takes 1 hour 5 minutes.
8. When the jam is finished, the Breadman® will beep and "0:00" will appear in the Display Window. Press the **STOP** Button and open the Lid.

### **CAUTION: THE OVEN CAVITY, BREAD PAN, KNEADING PADDLE AND BREAD WILL BE VERY HOT. USE OVEN MITTS.**

9. Remove the Bread Pan from the Breadman®. BE SURE TO USE OVEN MITTS.
10. Pour the hot jam into a heat-safe container. Leave on the counter top to partially cool, stir occasionally.
11. Pour the partially cool jam into a refrigerator/freezer-safe container, leaving 1/2" of space at the top.
12. Cover tightly to store. Jam will thicken upon cooling.





### ***Jam Course Hints For Best Results***

- Do not reduce sugar or use sugar substitutes. The exact amounts of sugar, fruit, and other ingredients are necessary for a good set.
- Use only ripe fruit (not overripe or underripe) for best flavor.
- Do not puree fruit. **Drain cubed fruit before crushing.** Crush with a potato masher or food processor. Jam should have bits of fruit in it.
- Recipes should not exceed 3 cups fruit.
- Be sure to measure fruit **AFTER** it has been crushed, not before.
- Remove stems, seeds, or pits from fruit before crushing.
- You may use strawberries, blackberries, raspberries or other thin skinned berries. Fruit such as peaches, pears and apricots may be used but should be peeled and have the seeds removed.
- Frozen berries or fruit (no sugar added) may be substituted for fresh. Thaw and drain before measuring. For thinner jam, use juice as part of the 3 cups berry or fruit amount.
- Lemon juice adds necessary acid to the berries or fruit.
- You may decrease the amount of sugar, but it will produce a thinner result. More sugar will make it thicker. For best results, sugar substitutes are not recommended.
- The average refrigerated life of jam is 2 weeks or up to several months frozen.

## ***STRAWBERRY, BLACKBERRY, OR RASPBERRY JAM***

Fresh or Frozen (thawed) Fruit	3 cups
Sugar	5 cups
Select Jam Course	13

## ***BLUEBERRY, APRICOT, PEACH OR PEAR JAM***

Fresh or Frozen (thawed) Fruit	3 cups
Sugar	5 cups
Lemon Juice	3 TBL
Select Jam Course	13

**CAUTION: DO NOT EXCEED THESE AMOUNTS!**



## USER MAINTENANCE INSTRUCTIONS

Any service requiring disassembly, other than the cleaning described below, must be performed by an authorized service representative. Unauthorized service will void your warranty.

## CLEANING INSTRUCTIONS

### Caution

#### Bread Pan and Kneading Paddle Cleaning Instructions

**ALWAYS UNPLUG THE UNIT AND ALLOW TO COOL COMPLETELY BEFORE CLEANING.**

The Bread Pan and Kneading Paddle have non-stick surfaces which make cleaning easy.

1. After baking each loaf of bread, unplug the Breadman® and discard any crumbs.
2. Remove the Bread Pan from the Oven Chamber and the Kneading Paddle from the Bread Pan. Then, as needed, wash the Bread Pan and Kneading Paddle inside and out with warm, soapy water. Avoid scratching the non-stick surfaces.

**DO NOT PUT THE PAN IN A DISHWASHER OR SOAK IT IN WATER.**

3. If the Kneading Paddle is stuck to the Drive Shaft, pour warm water into the Bread Pan for up to 30 minutes, to loosen it. **DO NOT USE EXCESSIVE FORCE.**
4. Wipe the inside of the Lid and Oven with a slightly damp cloth or sponge. If any residue has scorched on the Heating Element or elsewhere, wipe with a non-abrasive pad and wipe clean. The Lid can be removed for cleaning. **DO NOT PUT THE LID IN A DISHWASHER** since this can cause the Lid to warp. Because it contains a sensitive electronic sensor, **DO NOT LEAVE IT SOAKING IN WATER.**
5. To clean the glass in the Lid, use a glass cleaner or mild detergent and a damp cloth or plastic scouring pad. Do not use an abrasive cleaner or pad as they might scratch the glass.
6. Do not use vinegar, bleach, or harsh chemicals to clean the Breadman®.
7. Be sure the Breadman® is completely cooled before storing.
8. The Oven Chamber contains the Heating Element and Drive Shaft. Therefore, when cleaning, **NEVER pour water, solvents, or cleaning solutions into this area.**

## STORAGE

- All removable parts should be thoroughly cleaned and dried.
- Store with Lid closed. Place Bread Pan into the Breadman® with Kneading Paddle inside.





## BEFORE CALLING FOR SERVICE

Questions	Answers
<b>1</b> Why does the height and shape of bread differ in each loaf?	The height and shape of bread may differ depending on the ingredients, room temperature and length of the timer cycle. Also, accurate measurement of ingredients is essential to make delicious bread.
<b>2</b> The bread has an unusual aroma. Why?	Stale ingredients may have been used or too much yeast may have been used. Always use fresh ingredients. Accurate measurements are essential to make delicious bread.
<b>3</b> The Kneading Paddle comes out with the bread.	This can happen as the Kneading Paddle is detachable. Use a non-metal utensil to remove it. <b>CAUTION:</b> The Kneading Paddle will be hot.
<b>4</b> The bread has a floured corner.	Sometimes flour in the corner of the Bread Pan may not have been completely kneaded into the dough. Scrape it off the loaf with a knife.
<b>5</b> Can ingredients be halved or doubled?	<b>NO.</b> If there is too little in the Bread Pan, the Kneading Paddle cannot knead well enough. If there is too much, bread rises out of the Bread Pan.
<b>6</b> Can fresh milk be used in place of dry milk?	<b>YES.</b> Be sure to decrease the same measurement of water to equal liquid substitution. Fresh milk is not recommended when using the Delay Bake Timer, because it may spoil while sitting in the Bread Pan.



# CHECKLIST

BAKING RESULTS:		Bread Maker does not operate/ ingredients not mixing	Smoke emitted from steam vent/ burning smell	Sides of bread collapse/ bottom is damp	Bread rises too much/ coarse texture	Bread falls/ coarse texture	Short & dense texture	Slices uneven & sticky
								
Please check the following:								
OPERATIONAL ERRORS	1. Unplugged/power outage		<input type="radio"/>					
	2. Oven area is too hot (Display -- H, -- HI)		<input type="radio"/>					
	3. Oven area is too cold (Display -- L, -- LI)		<input type="radio"/>					
	4. Display reads: <input type="checkbox"/> <input type="checkbox"/> or <input type="checkbox"/> <input type="checkbox"/>		<input type="radio"/>					
	5. Ingredients spilled on heating element			<input type="radio"/>				
	6. Top Lid was open during baking							<input type="radio"/>
	7. Bread left in Bread Pan too long after program				<input type="radio"/>			
	8. Bread sliced just after baking (steam was not allowed to escape)							<input type="radio"/>
	9. Whole Wheat, Whole Wheat Rapid or Jam Course chosen		<input type="radio"/>					
	10. Kneading Paddle not installed		<input type="radio"/>					
INGREDIENT PROBLEMS	MEASUREMENT ERRORS	Water	11. Not enough					<input type="radio"/>
			12. Too much		<input type="radio"/>	<input type="radio"/>	<input type="radio"/>	
	Flour	13. Not enough					<input type="radio"/>	
		14. Too much						<input type="radio"/>
	Yeast	15. No yeast						<input type="radio"/>
		16. Not enough						<input type="radio"/>
		17. Too much				<input type="radio"/>	<input type="radio"/>	
	18. No sugar, molasses or honey							<input type="radio"/>
	19. Ingredients used other than recommended					<input type="radio"/>	<input type="radio"/>	<input type="radio"/>
	Flour	20. Wrong type of flour used						<input type="radio"/>
	Yeast	21. Yeast touched water before kneading						<input type="radio"/>
22. Old yeast used						<input type="radio"/>		
23. Wrong type of yeast used							<input type="radio"/>	
24. Temperature of water either too hot or too cold							<input type="radio"/>	



## SUGGESTIONS

The following suggestions have a corresponding number found on the checklist.  
Be sure to read both.

1.	Plug into 120 V ~ 60 Hz outlet. Refer to power outage instructions.
2 - 3.	Open Lid, remove Bread Pan and allow to cool or warm up.
4.	Needs service.
5.	Wait until Course is complete; unplug, allow to cool and clean.
6.	Only open Lid during kneading process to check dough ball or to add ingredients.
7.	Remove bread as soon as Course is done and place on wire rack.
8.	Allow to cool approximately 15 to 30 minutes.
9.	Courses begin with preheat. No movement occurs in the Bread Pan.
10.	Put Kneading Paddle on the shaft of Bread Pan.
11 - 14.	Check the dough ball at beep.
	It should be round, smooth-textured, soft and slightly tacky to the touch. (Deluxe Super Rapid dough ball will be sticky to the touch.)
	If more like a batter, add 1 TBL flour. Allow to mix; add more if necessary.
	If too dry, add 1 tsp water. Allow to absorb; add more if necessary.
15.	Follow recipe.
16.	Increase by 1/4 tsp.
17.	Decrease by 1/4 tsp.
18.	Sugar substitutes not recommended.
19.	Follow recipe or substitution recommendations.
20.	Flours cannot be substituted.
21.	Place yeast on top of flour away from liquids.
22.	Make sure yeast is fresh and at room temperature.
23.	For all Courses, except Deluxe Super Rapid, use active dry/rapid or quick rise in equal amounts. Follow bread machine yeast directions.
24.	Water should be 80°F/27°C for all Courses except Deluxe Super Rapid which should be 100°-115°F/43°-46°C.



## SPECIFICATIONS

Power Supply		120 V ~ 60 Hz
Power Consumption	Heater	430W
	Kneading Motor	70W
Dimension (WxDxH)		Approx. 16" x 9" x 13"
Weight		Approx. 15 LB



## RECIPE INDEX

BREAD RECIPES...AS EASY AS 1-2-3 .....	.22 - 23
WHITE BREAD RECIPES .....	.22 - 23
White Bread .....	.22
Jalapeno Bread .....	.23
White Sourdough Starter .....	.24
White Sourdough Bread .....	.24
Banana Bread .....	.25
Corn Bread .....	.25
Dill Bread .....	.26
Fat-Free White Bread .....	.26
Egg Bread .....	.27
Buttermilk Bread .....	.27
Honey Granola Bread .....	.28
Maple Bread .....	.28
Peach Bread .....	.29
Potato Bread .....	.29
Milk Bread .....	.30
Whole Grain Bread .....	.30
Bloody Mary Bread .....	.31
Banana Granola Bread .....	.31
WHOLE WHEAT BREAD RECIPES .....	.32
Sunflower & Sesame Seed Whole Wheat Bread .....	.32
Whole Wheat Bread .....	.32
Whole Wheat with Gluten Bread .....	.33
Whole Wheat Cinnamon Raisin Walnut Bread .....	.33
Southern Barley Bread .....	.34
Caraway Rye Bread .....	.34
Onion Rye Bread .....	.35
Anadama Oatmeal Bread .....	.35
Honey-Banana Whole Wheat Bread .....	.36



## RECIPE INDEX (CONTINUED)

Seven Grain Bread . . . . .	36
Two Cheese Bread . . . . .	37
Whole Wheat Zucchini Herb Bread . . . . .	37
Yogurt Whole Wheat Bread . . . . .	38
Pumpernickel Bread . . . . .	39
Dairy Whole Wheat Bread . . . . .	39
FRENCH BREAD RECIPES	
Hearty Nut Bread . . . . .	40
French Bread . . . . .	40
FRUIT & NUT BREAD RECIPES	
Italian Herb Bread . . . . .	41
Spiced Pumpkin Bread . . . . .	41
Cinnamon Raisin Bread . . . . .	42
Crunchy Cracked Wheat Bread . . . . .	42
Soy Herb Bread . . . . .	43
Sweet Walnut Bread . . . . .	43
White Wheat Bread . . . . .	44
Dried Fruit Bread . . . . .	44
Trail Mix Bread . . . . .	45
Soy Almond Fruit Bread . . . . .	45
Soy Cinnamon Raisin Bread . . . . .	46
Cheese Onion Bread . . . . .	46
Carrot Raisin Bread . . . . .	47





## RECIPE INDEX (CONTINUED)

DELUXE SUPER RAPID BREAD RECIPES . . . . .	48
Deluxe Super Rapid White Bread . . . . .	48 - 50
Deluxe Super Rapid Country White Bread . . . . .	50
Deluxe Super Rapid French Bread . . . . .	51
Deluxe Super Rapid Italian Bread . . . . .	51
Deluxe Super Rapid Cinnamon-Raisin Bread . . . . .	52
Deluxe Super Rapid Pepperoni Pizza Bread . . . . .	52
DAY OLD BREAD RECIPES . . . . .	53
Breaded Pineapple . . . . .	53
Bread Pudding . . . . .	53
Crunchy Bread Snacks . . . . .	53
BATTER BREADS™ RECIPES . . . . .	54 - 55
Sweet Corn Bread . . . . .	54
Pineapple Coconut Pound Cake . . . . .	56
Spiced Zucchini Bread . . . . .	56
Cheddar Loaf Bread . . . . .	57
Carrot Pecan Bread . . . . .	57
Banana Nut Cake . . . . .	58
BREAD / PIZZA / PASTA DOUGH COURSE RECIPES...AS EASY AS 1-2-3 . . . . .	59
Making Doughs: Crust Treatments . . . . .	60
Dinner Roll Dough . . . . .	61
Wheat Dinner Roll Dough . . . . .	62
Buttermilk Roll Dough . . . . .	63
Cheezy Garlic Roll Dough . . . . .	64
Refreshing Roll Dough . . . . .	65
Cinnamon Roll Dough . . . . .	66
Sticky Breakfast Bun Dough . . . . .	67
Brioche Roll Dough . . . . .	68
French Bread Dough . . . . .	69
Challah Bread Dough . . . . .	70



## RECIPE INDEX (CONTINUED)

Creamed Soup Bread Bowl Dough . . . . .	71
Party Dip Bread Bowl . . . . .	72
Shredded Beef Dip . . . . .	72
Shrimp Dip . . . . .	72
Almond-Cherry Coffee Cake Dough . . . . .	73
Bagel Dough . . . . .	74
Banana Wheat Bagel Dough . . . . .	75
Egg Bagels . . . . .	76
Soft Pretzel Dough . . . . .	77
Pita Pocket Dough . . . . .	78
Pizza Crust Dough . . . . .	79
Whole Wheat Pizza Crust Dough . . . . .	79
Rustic Pizza Margherita . . . . .	80
Focaccia Dough . . . . .	81
PASTA DOUGH RECIPES	
Basic Pasta Dough . . . . .	.82 - 83
Egg Pasta Dough . . . . .	.83
Spinach Pasta Dough . . . . .	.83
Dumplings . . . . .	.84
Pie Crust . . . . .	.84
Amaretto Raisin Cookies . . . . .	.85
Oatmeal Raisin Cookies . . . . .	.85
JAM COURSE RECIPES...AS EASY AS 1-2-3 . . . . .	.86 - 87
Strawberry, Blackberry, or Raspberry Jam . . . . .	.87
Blueberry, Apricot, Peach or Pear Jam . . . . .	.87

# LIMITED ONE YEAR WARRANTY

**Warranty:** This Breadman® product is warranted by Salton, Inc. to be free from defects in materials or workmanship for a period of (1) year from the original purchase date. This product warranty covers only the original consumer purchaser of the product.

**Warranty Coverage:** This warranty is void if the product has been damaged by accident in shipment, unreasonable use, misuse, neglect, improper service, commercial use, repairs by unauthorized personnel, normal wear and tear, improper assembly, installation or maintenance abuse or other causes not arising out of defects in materials or workmanship. This warranty is effective only if the product is purchased and operated in the USA, and does not extend to any units which have been used in violation of written instructions furnished with the product or to units which have been altered or modified or to damage to products or parts thereof which have had the serial number removed, altered, defaced or rendered illegible. Wear and tear for Bread Pans and Paddles is not considered a manufacturer's defect.

**Implied Warranties:** ANY IMPLIED WARRANTIES WHICH THE PURCHASER MAY HAVE ARE LIMITED IN DURATION TO ONE (1) YEAR FROM THE DATE OF PURCHASE. Some states do not allow limitations on how long an implied warranty lasts, so the above limitation may not apply to you.

**Warranty Performance:** During the above one-year warranty period, a product with a defect will be either repaired or replaced with a reconditioned comparable model (at our option) when the product is returned to the Repair Center, or the purchase price refunded. The repaired or replacement product will be in warranty for the balance of the one-year warranty period and an additional one-month period. No charge will be made for such repair or replacement.

**Service and Repair:** Should the appliance malfunction, you should first call toll-free 1 (800) 233-9054 between the hours of 9:00 am and 5:00 pm Central Standard Time and ask for CONSUMER SERVICE stating that you are a consumer with a problem. Please refer to model number TR846 when you call.

**In-Warranty Service (USA):** For an appliance covered under the warranty period, no charge is made for service or postage. Call for return authorization 1 (800) 233-9054.

**Out-of Warranty Service:** A flat rate charge by model is made for out-of-warranty service. Include \$15.00 (U.S.) for return shipping and handling. We will notify you by mail of the amount of the charge for service and require you to pay in advance for the repair or replacement.

**For Products Purchased in the USA, but Used in Canada:** You may return the product insured, packaged with sufficient protection, and postage and insurance prepaid to the USA address listed below. Please note that all customs duty / brokerage fees, if any, must be paid by you and we will require you to pay the cost of customs duty / brokerage fees to us in advance of our performing any service.

**Risk During Shipment:** We cannot assume responsibility for loss or damage during incoming shipment. For your protection, carefully package the product for shipment and insure it with the carrier. Be sure to enclose the following items with your appliance: any accessories related to your problem, your full return address and daytime phone number, a note describing the problem you experienced, a copy of your sales receipt or other proof of purchase to determine warranty status. C.O.D. shipments cannot be accepted.

**To return the appliance, ship to:**

ATTN: Repair Center  
Salton, Inc.  
708 South Missouri Street  
Macon, MO 63552

**To contact us, please write to, call, or email:**

Salton, Inc.  
P.O. Box 7366  
Columbia, MO 65205-7366  
1 (800) 233-9054  
E-mail: Salton@Saltonusa.com

**Limitation of Remedies:** No representative or person is authorized to assume for Salton, Inc. any other liability in connection with the sale of our products. There shall be no claims for defects or failure of performance or product failure under any theory of tort, contract or commercial law including, but not limited to negligence, gross negligence, strict liability, breach of warranty and breach of contract. Repair, replacement or refund shall be the sole remedy of the purchaser under this warranty, and **in no event shall Salton be liable for any incidental or consequential damages, losses or expenses.** Some states do not allow the exclusion or limitation of incidental or consequential damages, so the above limitation or exclusion may not apply to you.

**Legal Rights:** This warranty gives you specific legal rights, and you may also have other rights which vary from state to state.

For more information on Salton products: visit our website: [www.breadman.com](http://www.breadman.com), or email us at: [breadman@saltonusa.com](mailto:breadman@saltonusa.com) or [eSalton.com](mailto:eSalton.com)

## IMPORTANT NOTICE

*If any parts are missing or defective,  
**DO NOT** return this product.*

*Please call our Consumer Service Department for assistance.*

**800-233-9054** Monday - Friday 8am - 5pm CST

*Thank You*



If after reading this instruction  
booklet you still have questions about using the  
Breadman® Automatic Bread Maker,  
please write or call:

Salton, Inc.  
P.O. Box 7366  
Columbia, MO 65205-7366  
1-800-233-9054  
Monday - Friday 8am - 5pm CST

For more information on Salton, Inc. products, E-mail us at:

[breadman@saltonusa.com](mailto:breadman@saltonusa.com)

OR, visit our website:

<http://www.breadman.com>

or [www.eSalton.com](http://www.eSalton.com)