

**READ AND SAVE THESE INSTRUCTIONS**

 **Toaster**<sup>®</sup>

**Corner Bakery Bread & Dessert Maker**



**Use and Care Guide  
Models 1183X and 1170X**

**?? QUESTIONS ??**

Before Contacting Your Retailer Call

**TOLL-FREE 1-800-947-3744**

and talk to one of Toastmaster's Experts.

**WARNING:** A risk of fire and electrical shock exists in all electrical appliances and may cause personal injury or death. Please follow all safety instructions.

# TABLE OF CONTENTS

---

<b>IMPORTANT SAFEGUARDS</b> .....	3
<b>BEFORE YOUR FIRST USE</b> .....	4
<b>CORNER BAKERY BREAD &amp; DESSERT MAKER INTRODUCTION</b>	
Parts and Accessories .....	5
Control Panel .....	6
Basic Features .....	7
Program Specifications .....	8
<b>BREAD AND DOUGH</b>	
Programming .....	9
Helpful Hints and Recipes .....	Refer to Recipe Book
<b>BUTTER</b>	
Programming .....	12
Helpful Hints and Recipes .....	Refer to Recipe Book
<b>DESSERT</b>	
Programming .....	14
Helpful Hints and Recipes .....	Refer to Recipe Book
<b>CLEANING INSTRUCTIONS</b> .....	16
<b>BEFORE CALLING FOR SERVICE</b> .....	17
Bread and Dough Questions and Answers .....	17
Checklist for Bread .....	18
Dessert Questions and Answers .....	20
Service Information .....	21
<b>SPECIFICATIONS</b> .....	21

# IMPORTANT SAFEGUARDS

---

When using electrical appliances, basic safety precautions should always be followed to reduce the risk of fire, electric shock and injury to persons, including the following:

- **Read all instructions before using this appliance.**
- To protect against electric shock do not immerse cord, plug, or Bread Maker in water or other liquid (see instructions for cleaning).
- Do not touch hot surfaces. Always use oven mitts when handling the hot pan, dessert or bread.
- This Bread Maker is not for use by children. Keep out of reach of children.
- Close supervision is necessary when this Bread Maker is used near children.
- Unplug from outlet when not in use and before cleaning. Press stop button before unplugging. Allow to cool before attaching or removing parts.
- Avoid touching moving parts. Do not insert hand into the pan during operation.
- Do not operate the Bread Maker with a damaged cord or plug, or after the Bread Maker malfunctions, or has been dropped or damaged in any manner. Return Bread Maker to the nearest authorized service facility for examination, repair, electrical or mechanical adjustment.
- Do not use outdoors or while standing in damp area.
- Do not let cord hang over edge of table or counter or touch hot surfaces.
- Do not place on or near hot gas or electric burner or in a heated oven.
- To disconnect, press the STOP button, then grip the plug and pull out from the wall outlet. Never pull on the cord.
- Do not use Bread Maker for other than intended use.
- This product is intended for household use only.
- Use accessory attachments only if recommended by Toastmaster Inc.
- Do not clean with metal scouring pads. Pieces can break off the pad and touch electrical parts, creating a risk of electrical shock.
- Bread Maker must be placed at least 4 inches (10.2 cm) from walls and edge of counter.
- Do not cover Bread Maker with anything which would prevent the steam escaping. This may cause warpage, discoloration, malfunction or even fire.

## SAVE THESE INSTRUCTIONS

### THIS PRODUCT FOR HOUSEHOLD USE ONLY.

**CAUTION:** A short power supply cord is provided to reduce the risk of personal injury resulting from becoming entangled in or tripping over a longer cord. Extension cords are available from local hardware stores and may be used if care is exercised in their use. If an extension cord is required, special care and caution is necessary. Also the cord must be: (1) marked with an electrical rating of 125 V, and at least 13 A., 1625 W., and (2) the cord must be arranged so that it will not drape over the countertop or tabletop where it can be pulled on by children or tripped over accidentally.

**ELECTRIC POWER:** If electric circuit is overloaded with other appliances, your Bread Maker may not operate properly. The Bread Maker should be operated on a separate electrical circuit from other operating appliances.

**POLARIZED PLUG:** This appliance has a polarized plug, (one blade is wider than the other). As a safety feature to reduce the risk of electrical shock, this plug is intended to fit in a polarized outlet only one way. If the plug does not fit fully in the outlet, reverse the plug. If it still does not fit, contact a qualified electrician. Do not attempt to defeat this safety feature.

# BEFORE YOUR FIRST USE

---

Carefully unpack the Bread & Dessert Maker removing all packaging materials. To remove any dust that may have accumulated during packaging, wash the pan, kneading blade, butter lid and liquid measuring cup. Do not immerse pan. (See cleaning instruction on page 16.) Wipe the outside of the machine with a damp cloth. Do not use harsh or abrasive cleaners on any part of the Bread & Dessert Maker.

Place the Bread & Dessert Maker away from edge of counter on a dry, stable surface away from burners and away from areas where cooking grease or water may splatter onto it.

Plug the Bread & Dessert Maker into a 120 V ~ 60 Hz outlet.

## IMPORTANT SAFETY TIPS

- Unplug unit and allow to cool before cleaning. Remove any flour, bread crumbs or other materials from the inside of the inner case using a damp sponge, cloth or a small, portable vacuum cleaner.
- The bread maker will bake up to a 2 pound loaf of bread. Do not put a larger quantity of ingredients into the pan than recommended. If you do so, the bread may not mix or bake correctly and the bread maker may be damaged. The maximum amount of flour to be used is as follows:
  - BAKE settings — approximately 4 cups
  - Prepackaged bread mixes — 4 cups
  - DOUGH setting — 4 2/3 cups
- The dessert recipes have been developed specifically for the Toastmaster® Bread & Dessert Maker. We do not recommend using more or less ingredients than specified in each recipe.
- Handle hot pan with care using pot holders or oven mitts. Remove the pan by pulling straight up on the handle. Do not turn or shake the pan while taking it out. If the pan is damaged or bent, the temperature sensor will not work properly.

## POWER OUTAGE

During the bread programs if the machine loses power before the second rise, you can try starting the machine at the beginning of the cycle again. This may not always produce an acceptable loaf. If you are not sure when the outage occurred, **remove the dough ball from the pan** and place in an oven-safe baking container. Allow to double in size and place in a preheated 350°F/177°C oven for 25-30 minutes or until done. The bread should sound hollow when tapped on the top of the loaf when it is done.

If the bread has already begun to bake when the outage occurs, you must begin with new ingredients. Should a power outage occur during the dessert program, provided it has not begun to bake, you can try starting the program from the beginning. This may not always produce an acceptable result.

# CORNER BAKERY BREAD & DESSERT MAKER INTRODUCTION

The illustrations in this use and care guide are for information purposes only. You may find your bread maker and parts look different, however, the steps for operation are the same.

## ■ Parts

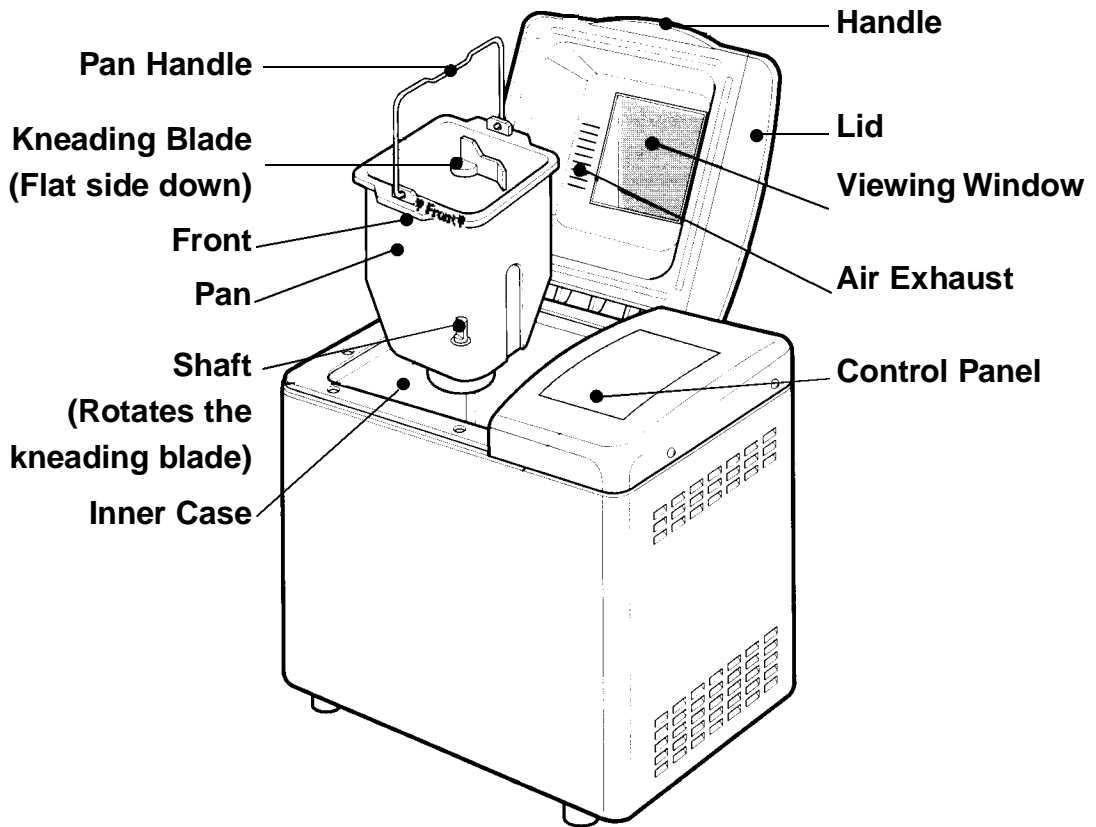

## Accessories

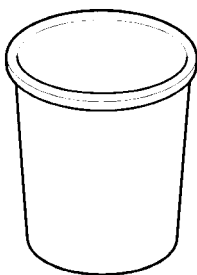

Liquid Measuring Cup  
(1 cup)

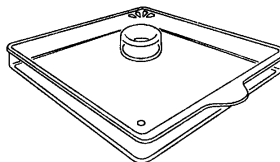

Lid for Butter  
(USE THIS LID FOR  
BUTTER PROGRAM ONLY)

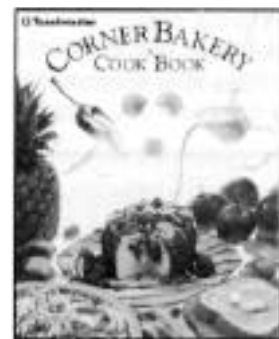

Full Color Recipe Book  
for Breads, Doughs, Butters  
and Desserts

## Control Panel

### DISPLAY WINDOW

Indicates the number of program, crust color (if making bread), and amount of time left for completion of program. Indicates display signals. (See page 9 for bread or dough programs, page 12 for butter program and page 14 for dessert program).

### SELECT

Press until program number is displayed in display window for all programs except Dessert.

### BAKING

Press to select light or dark crust color for bread programs only; medium is preset. Use light crust for breads high in sugar.

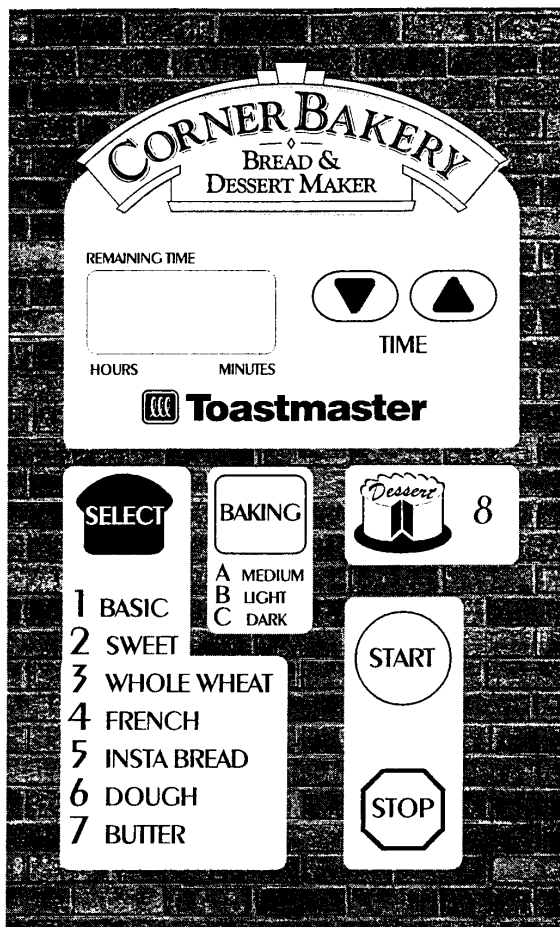

### TIME

Press arrows to delay program. The time will advance in 10 minute intervals to 13:00 hours. Press the START pad; the colon will blink. The timer cannot be used on Butter or Dessert programs.

### DESSERT

Press to select the Dessert program. The number 8 will be in the display window.

### START

After selecting the program, the baking control and timer (if needed), press to start the program or timer count down.

### STOP

Press and hold for more than 2 seconds during the cycle to cancel a program.

When a Bread & Dessert Maker is packaged for shipment, a clear plastic film is placed over the control panel as protection. This film may either be removed or left on. You may choose to leave it on, but it will come off with use.

#### PROGRAM CANCEL

If you want to cancel the selected program, press the STOP pad and hold it down for more than 2 seconds at any time during the cycle.

### PROGRAM SELECT RECALL

If you have started the Bread & Dessert Maker and are not sure which program you have selected, you may recall this information. Press and hold the start pad anytime. The number of the program and the crust color selection (if making bread) will appear in the display window.

## ■ Basic Features

### PROGRAM SELECT

All Toastmaster™ recipes tell you what program to select for each recipe. Refer to prepackaged bread mix directions for program selection for each specific mix.

The Dessert program contains an audible signal to check for proper mixing. The Sweet, Whole Wheat and Dessert programs contain an audible signal to add additional ingredients (i.e., raisins, nuts). Refer to program specification page 8.

- **BASIC** ..... Use this program for basic bread recipes and most packaged bread mixes.



- **SWEET** ..... This program works best if a recipe is high in sugar, fat, eggs or cheese.



- **WHOLE WHEAT** ..... If a recipe contains more than 50% whole wheat flour, use this program. During the first 20 minutes, the bread machine is preheating prior to first knead.



- **FRENCH** ..... This program is best suited for breads low in fat and sugar, which results in a crisp crust and a coarse, chewy interior.

- **INSTA BREAD** ..... Save time by using this program on recipes indicated with a **5** in the Bread Index of the recipe book. Simply omit the amount of active dry yeast called for in the recipe and use the larger amount of active dry yeast listed for the Insta program instead.

- **DOUGH** ..... This program is used to prepare dough for making bread or rolls which are shaped before baking in a conventional oven.

- **BUTTER** ..... The kneading blade churns the heavy whipping cream for 30 minutes. The heating element does not warm the inner case.

- **DESSERT** ..... This program will mix and bake/cook cakes, cheesecakes, pie fillings/puddings and fudge.



## Program Specifications

Program Process	1 BASIC	2 SWEET	3 WHOLE WHEAT	4 FRENCH	5 INSTA	6 DOUGH	7 BUTTER	8 DESSERT
1 delay timer	3:50-13:00	3:50-13:00	4:10-13:00	3:50-13:00	2:09-13:00	1:13-13:00	—	—
2 preheat	—	—	20 min.	—	—	—	—	—
3 mix	2 min	2 min	2 min	2 min	2 min	2 min	—	2 min
4 1st knead	5 min	5 min	11 min	11 min	5 min	4 min	—	5 min
5 display time for beep to stir*	—	—	—	—	—	—	—	1:48
6 rest	5 min	5 min	50 min	50 min	—	5 min	—	5 min
7 2nd knead	12 min	12 min	12 min	12 min	17 min	12 min	—	8 min
8 display time for beep to add**	—	3:25	2:34	—	—	—	—	1:20
9 1st rise	40 min	40 min	20 min	20 min	17 min	40 min	—	20 min
10 punch	4 sec	4 sec	4 sec	4 sec	4 sec	4 sec	—	—
11 2nd rise	26 min	26 min	15 min	15 min	8 min	—	—	—
12 punch	4 sec	4 sec	4 sec	4 sec	4 sec	—	—	—
13 3rd rise	60 min	60 min	40 min	40 min	30 min	—	—	—
14 bake/cook	50 min	50 min	50 min	50 min	40 min	—	—	55 min
15 cool	20 min	20 min	20 min	20 min	—	—	—	20 min
16 churn	—	—	—	—	—	—	30 min	—
17 End	[ :H]	[ :H]	[ :H]	[ :H]	[ :H]	End	End	End
18 TOTAL	3:40	3:40	4:00	3:40	1:59	1:03	:30	1:55
19 hold warm	3 hours	3 hours	3 hours	3 hours	3 hours	—	—	—

\*The Dessert program will beep 2 times when the display reads 1:48 as a reminder to stir the ingredients.

\*\*The Sweet, Whole Wheat, and Dessert programs will beep to tell you when to add additional ingredients, i.e. raisins or nuts, in specialty breads or when to add ingredients in desserts.

At the end of all bread programs a [ :H] is in the display window. You may remove the bread or leave it in the bread machine. If left, it will automatically be kept warm for up to 3 hours during the hold warm process on all bread cycles.

At the end of all other programs, End is in the display window. The bread pan should be removed unless instructed otherwise in the recipe.



# BREAD AND DOUGH

## ■ Programming

USE PLASTIC LID FOR BUTTER PROGRAM ONLY.

The illustrations in this use and care guide are for information purposes only. You may find your bread maker and parts look different, however, the steps for operation are the same.

- 1** Open the lid and remove the pan by pulling straight up, using the handle.

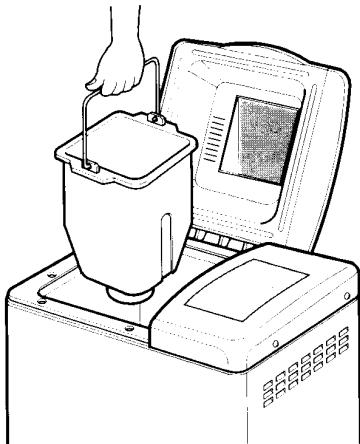

- 2** Mount the kneading blade on the shaft, flat side down.

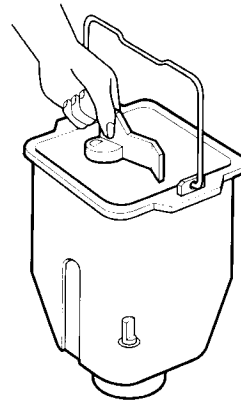

- 3** Place all ingredients in pan in the order listed.

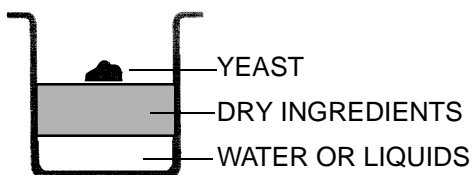

**NOTE:** When using the delay timer, add the yeast last on top of the flour and away from the liquid. This is critical for good results.

- 4** Insert pan until it fits securely into bottom of bread maker with the ▼ FRONT ▼ marking facing the front of the bread maker. This will provide a more even airflow during baking/cooking.

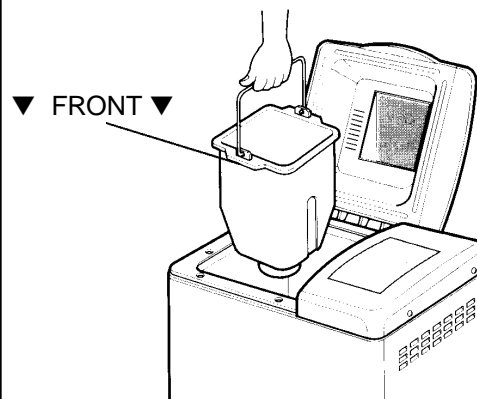

**5** Close the lid. Plug into 120 V ~ 60 Hz outlet. The display indicator will light up.

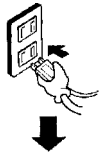

The bread machine may emit an odor and/or smoke during first use from oils used in manufacturing. This is normal for a new appliance.

**6** Select program and baking control. 

The Baking function is used to select the bread crust color. It can be baked medium, light or dark. It is not necessary to press the control when medium is desired. Place bread machine away from edge of counter.

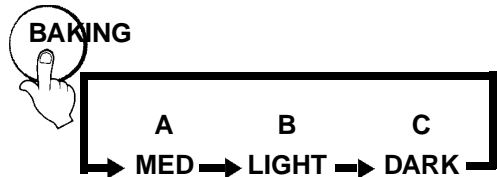

**7** Press START. The time left for the program to be finished is displayed and counts down. The Sweet and Whole Wheat programs will  beep to add additional ingredients during the second knead. Opening lid will not stop kneading. Add ingredients quickly and evenly over dough to prevent heat loss. Close lid.



If using the delay timer, add all of the ingredients at the beginning. The ingredients will be chopped into smaller pieces.

**8** The beeper will sound 8 times when bread is done. Press STOP and remove the pan using oven mitts.

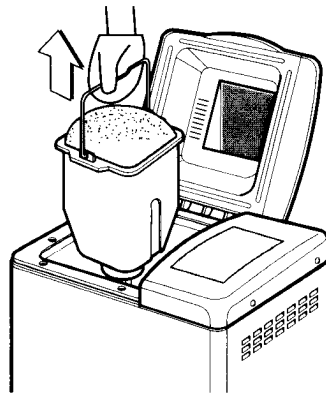

- 9** Turn the pan upside down and shake the pan several times to release the bread.

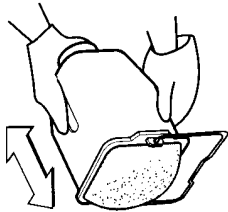

Place the bread upright on a wire rack to cool approximately 20 minutes before cutting. This allows the steam to escape. Be sure to remove the kneading blade from the bread.

**CAUTION:**

- The pan, kneading blade, and bread will be very hot.
- Always unplug after use.

**NOTE:** The unit must be allowed to cool down between each use.

**■ Programming The Delay Timer For Bread or Dough**

When delaying bread, reduce the amount of water by 1-3 teaspoons, depending on the size of loaf. Set the program and bread baking control. Before pressing START, set the timer for however long you want to wait before the bread is DONE: (up to 13 hours.) Add all of ingredients, including those specified “Add at the beep,” at the beginning. The ingredients will be chopped into smaller pieces.

**EXAMPLE:** It is 9:00 p.m. now. The bread is to be ready at 6:30 a.m. the next morning. Set the timer for 9:30, because there are 9 hours and 30 minutes between 9:00 p.m. and 6:30 a.m.

	1. When pressed, the time will advance in 10 minute increments.	<b>NOTE:</b> The bread maker will start when the timer reaches the time of the program selected.
	2. When constant pressure is applied to the pad, the time will advance quickly.	
	3. Press the START pad. The timer is set, and the colon blinks. After one minute, 9:29 is displayed, and the timer continues to count down in 1 minute increments.	 Colon will blink

# BUTTER

## ■ Programming

The butter program DOES NOT have a delay feature.

USE PLASTIC LID FOR BUTTER PROGRAM ONLY.

- 1** Open the lid and remove the pan by pulling straight up, using the handle.

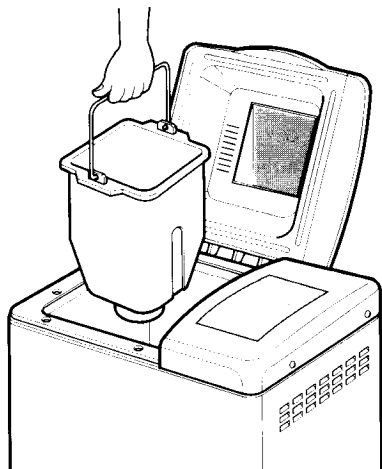

- 2** Mount the kneading blade on the shaft, flat side down.

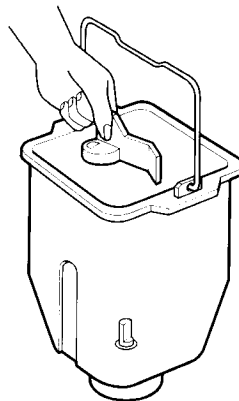

- 3** Pour heavy whipping cream in pan. Put on butter lid. USE THE PLASTIC LID FOR BUTTER PROGRAM ONLY.

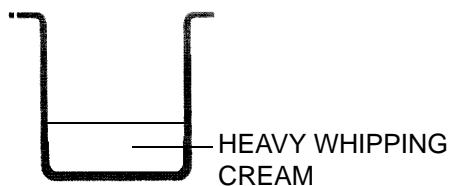

- 4** Insert pan until it fits securely into bottom of bread maker with the ▼ FRONT ▼ marking facing the front of the bread maker. This will provide more even airflow.

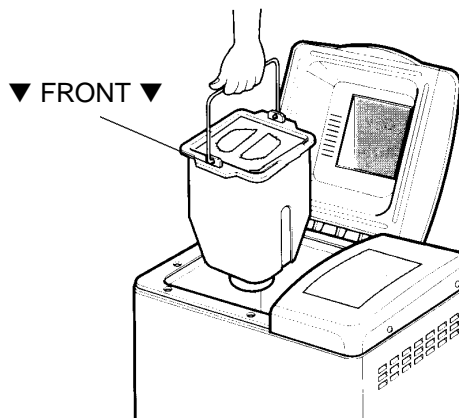

- 5** Close the lid. Plug into 120 V ~ 60 Hz outlet. The display indicator will light up.

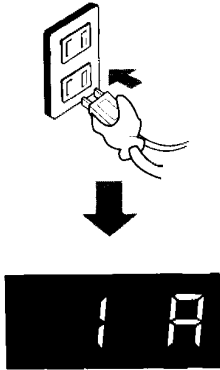

- 6** Select butter program.



- 7** Press START. The time left for the program to be finished is displayed and counts down.



- 8** The beeper will sound 8 times when butter is done. Press STOP and remove the pan.

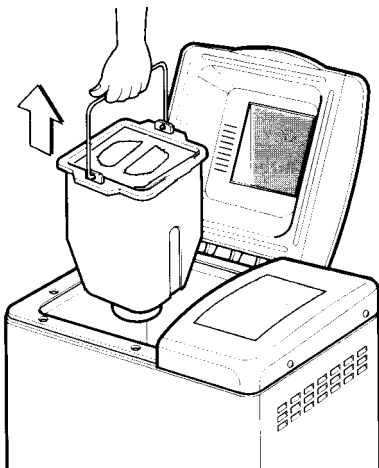

- 9** Without removing butter lid, tilt the pan, pouring the buttermilk off the butter. Remove butter from pan using a rubber or plastic spatula.

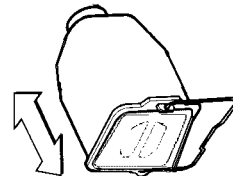

**CAUTION:**

- Always unplug after use.

# DESSERT

## ■ Programming

The dessert program DOES NOT have a delay feature.

USE PLASTIC LID FOR BUTTER PROGRAM ONLY.

- 1** Open the lid and remove the pan by pulling straight up, using the handle.

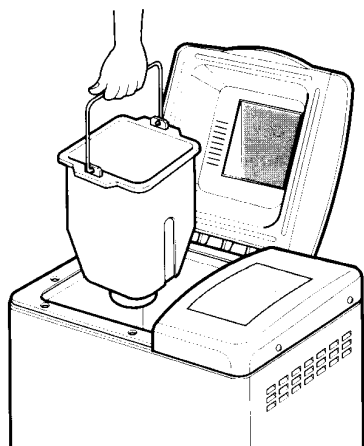

- 2** Mount the kneading blade on the shaft, flat side down.

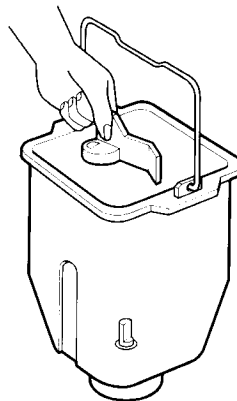

- 3** Place all ingredients in pan in the order listed. No mixing of ingredients outside the machine is necessary.

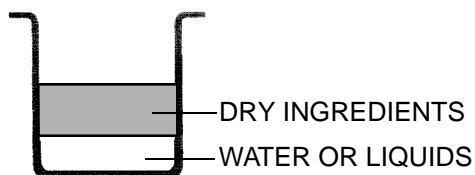

- 4** Insert pan until it fits securely into bottom of bread maker with the ▼ FRONT ▼ marking facing the front of the bread maker. This will provide a more even airflow during baking/cooking.

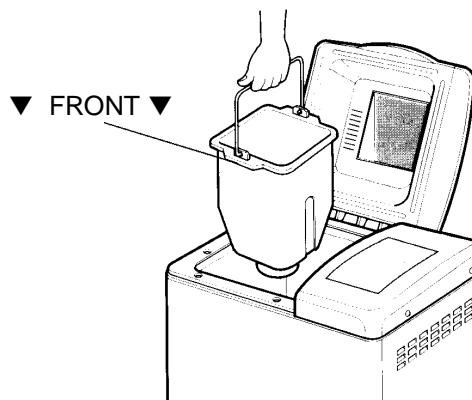

**5** Close the lid. Plug into 120 V

~ 60 Hz outlet. The display indicator will light up. The bread machine may emit an odor and/or smoke during first use from oils used in manufacturing.

This is normal for a new appliance.

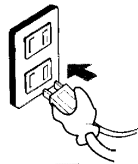

**6** Press Dessert button (cake). Place bread machine away from edge of counter.



**7** Press START. The time left for the program to be finished is displayed and counts down.

When the display reads 1:48 the machine will beep



2 times and stop mixing. Take a spatula and scrape the dry ingredients from the top sides and bottom corners of the pan into the wet mixture. At 1:43 mixing will resume. When the display reads 1:20 it will beep 4 times to add additional ingredients. Add ingredients quickly and evenly over batter to prevent heat loss. Close lid.



**8** The beeper will sound 8 times when dessert is done. Press STOP and remove the pan using oven mitts for all desserts EXCEPT cheesecakes. See special instructions for cheesecakes in the recipe book.

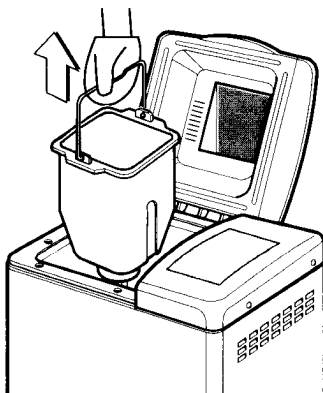

**9** Place the pan on a heat resistant surface. Refer to recipe book for additional mixing, cooling and removing instructions.

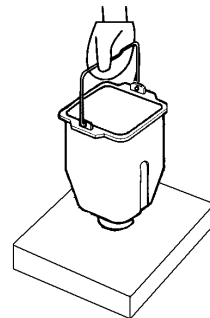

**CAUTION:**

- The pan, kneading blade, and dessert will be very hot.
- Always unplug after use.

# CLEANING INSTRUCTIONS

## CLEANING (Always unplug unit)

ANY SERVICING REQUIRING DISASSEMBLY, OTHER THAN THE CLEANING DESCRIBED BELOW, MUST BE PERFORMED BY AN AUTHORIZED SERVICE REPRESENTATIVE. UNAUTHORIZED SERVICE WILL VOID YOUR WARRANTY.

- Clean bread machine and parts after each use.
- Avoid using any cleaning agents other than dish detergent.
- Do not use steel wool or other abrasive materials.
- Do not wash any parts in the dishwasher.

- DO NOT IMMERSE the pan in water. Fill the pan with hot soapy water and allow to soak for up to 30 minutes. Wash it with a nylon bristle brush or cloth and dry thoroughly.



- Do not place pan in conventional oven.

- For best results, remove the kneading blade after each use for cleaning. If you do not it will become very difficult to remove.
- To remove, fill the pan with hot soapy water and allow it to soak for up to 30 minutes. Wash it with a nylon bristle brush or cloth and dry thoroughly.

- Wipe the exterior with a damp dishcloth after each use.
- Do not immerse the appliance in or splash with water.
- After using, cool and wipe out the oven interior with a damp dishcloth or plastic scouring pad.

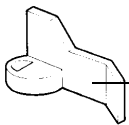

KNEADING BLADE

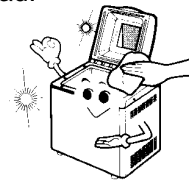

- Wipe the shaft with a soft cloth or sponge to prevent damage to the seal packing. Allow to dry before storing the pan inside the Bread & Dessert Maker.

- Do not use metal utensils inside the pan. They will damage the non-stick coating. If the bread sticks to the lid, use a plastic pancake turner to clean.

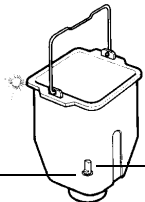

SEAL PACKING

SHAFT

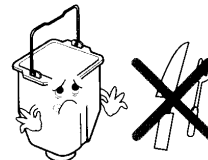

- The nonstick bread pan and blade will show normal wear with use.

- The non-stick coating may change color over time. This is caused by moisture and steam and in no way affects performance.

## STORING

- Be sure the Bread & Dessert Maker is completely cooled before storing.
- All removable parts should be thoroughly cleaned and dried after each use.
- Store with lid closed.



# BEFORE CALLING FOR SERVICE

## ■ Bread and Dough Questions and Answers

Questions	Answers
<b>1</b> Why does the height and shape of bread differ in each loaf?	The height and shape of bread may differ depending on the ingredients, room temperature and length of the timer cycle. Also accurate measurement of ingredients is essential to make delicious bread.
<b>2</b> The bread has an unusual aroma. Why?	Stale ingredients or too much yeast may have been used. Always use fresh ingredients. Accurate measurements are essential to make delicious bread.
<b>3</b> The kneading blade comes out with the bread.	This can happen as the kneading blade is detachable. Use a non-metal utensil to remove it.  <b>Caution:</b> The kneading blade will be hot.
<b>4</b> The baked loaf of bread has a floured corner.	Sometimes flour in the corner of the pan may not have been completely kneaded into the dough. Scrape the flour off the loaf with a spatula.
<b>5</b> Why can the timer not be set for more than 13 hours?	Longer delay times could alter the baking results.
<b>6</b> Can ingredients be halved or doubled?	No. If there is too little in the pan, the kneading blade cannot knead well enough. If there is too much, bread swells out of the pan.
<b>7</b> Can fresh milk be used in place of dry milk?	Yes. Be sure to deduct the same measurement of water to equal liquid substitution (warm to 80°F/27°C). Fresh milk is not recommended when using the timer, because it may spoil while sitting in the pan.

# Checklist for Bread

BAKING RESULTS:		Bread maker does not operate/ ingredients not mixing	Smoke emitted from steam vent/ burning smell	Sides of bread collapse/ bottom is damp	Bread rises too much/ coarse texture	Bread falls/ coarse texture	Short & dense texture	Slices uneven & sticky	
									
Please check the following:									
<b>OPERATIONAL ERRORS</b>	1. Unplugged/power outage		<input type="radio"/>						
	2. Oven area is too hot (display H I )		<input type="radio"/>						
	3. Display reads E:02,E:03,E:04,E:05,E:08		<input type="radio"/>						
	4. Ingredients spilled on heating element			<input type="radio"/>					
	5. Top lid was open during baking						<input type="radio"/>		
	6. Bread left in pan too long after program or water not reduced for delay				<input type="radio"/>				
	7. Bread sliced just after baking (Steam was not allowed to escape)							<input type="radio"/>	
	8. Whole Wheat program chosen		<input type="radio"/>						
	9. Kneading blade not installed		<input type="radio"/>						
<b>INGREDIENT PROBLEMS</b>	Water	10. Not enough					<input type="radio"/>		
		11. Too much		<input type="radio"/>	<input type="radio"/>	<input type="radio"/>			
	Flour	12. Not enough				<input type="radio"/>			
		13. Too much					<input type="radio"/>		
	Yeast	14. No yeast					<input type="radio"/>		
		15. Not enough					<input type="radio"/>		
		16. Too much				<input type="radio"/>	<input type="radio"/>		
	17. No sugar, molasses or honey						<input type="radio"/>		
	18. Ingredients used other than recommended					<input type="radio"/>	<input type="radio"/>	<input type="radio"/>	
	Flour	19. Wrong type of flour used						<input type="radio"/>	
	Yeast	20. Yeast touched water before kneading						<input type="radio"/>	
		21. Old yeast used						<input type="radio"/>	
		22. Wrong type of yeast used						<input type="radio"/>	
23. Temperature of water either too hot or too cold							<input type="radio"/>		

## ■ Suggestions

The following suggestions have a corresponding number found on the checklist. Be sure to read both.

1. Plug into 120 V ~ 60 Hz outlet. Refer to page 4 for power outage instruction.
2. Open lid, remove pan and allow to cool.
3. Needs service.                      Call toll free 1-800-947-3744.
4. Wait until program is complete; unplug, allow to cool and clean.
5. Only open lid during kneading process to check dough ball or to add ingredients.
6. Remove bread as soon as program is done and place on wire rack. When delaying bread, reduce the amount of water by 1-3 teaspoons.
7. Allow to cool approximately 20 minutes.
8. Program begins with 20 minute preheat.
9. Put kneading blade on the shaft of pan.
10 - 13. Check the dough ball halfway through the 1st kneading cycle.
It should be round, smooth-textured, soft and slightly tacky to the touch.
If more like a batter, add 1 TBL flour. Allow to mix; add more if necessary.
If too dry add 1 tsp water. Allow to absorb; add more if necessary.
14. Follow recipe.
15. Increase by 1/4 tsp.
16. Decrease by 1/4 tsp.
17. Sugar substitutes not recommended.
18. Follow recipe or substitution recommendations.
19. Flours cannot be substituted.
20. Place yeast on top of flour away from liquids.
21. Make sure yeast is fresh and room temperature.
22. Use active dry/rapid or quick in equal amounts. Follow bread machine yeast directions.
23. Water should be 80°F/27°C.

# BEFORE CALLING FOR SERVICE

## ■ Dessert Questions and Answers

Questions	Answers
<b>1</b> Why does the height and shape of the desserts vary?	The height and shape of desserts may differ depending on the ingredients. Accurate measurement of ingredients is essential to make delicious dessert.
<b>2</b> The kneading blade comes out with the dessert.	This can happen as the kneading blade is detachable. Use a non-metal utensil to remove it.
<b>3</b> The dessert has a floured corner.	Be sure and stir the dessert when it beeps 2 times at 1:48.
<b>4</b> Can the timer be used?	No, the ingredients will not mix and bake properly. Most of the recipes have perishable ingredients and you must stir the ingredients at 1:48.
<b>5</b> Can ingredients be halved or doubled?	No. If there is too little in the pan, the kneading blade cannot mix well enough. If there is too much, the Bread & Dessert Maker will not cook properly.
<b>6</b> Can fresh milk be used in place of dry milk?	Yes. Be sure to deduct the same measurement of water to equal liquid substitution.
<b>7</b> Do I have to use egg replacement in the eggs filling and pudding?	Yes, egg replacement must be used because eggs will curdle when making these recipes.

# SERVICE INFORMATION

---

Please refer to warranty statement to determine if in-warranty service applies.

This appliance must be serviced by a Toastmaster authorized service center. Unauthorized service will void warranty. Consult your phone directory under "Appliances-Household-Small-Service and Repair", or call 1-800-947-3744.

If an authorized service center is not available locally, your appliance may be returned postage prepaid to our National Service Center at the address shown in the warranty statement. Products must be adequately protected to avoid shipping damage. Surround your appliance with three inches of protective padding and include a note explaining the problem you have experienced along with a copy of the dated sales receipt. We recommend insuring your package. No C.O.D. shipments accepted.

# SPECIFICATIONS

---

Power supply		120 V ~ 60 Hz
Power Consumption	Heater	430W
	Kneading Motor	75W
Dimension (WxDxH)		13 1/2" x 10" x 13 1/2"
Weight		Approx. 19 lbs.

# NOTES

---

# NOTES

---

## ONE YEAR LIMITED WARRANTY

Toastmaster Inc. warrants this product, to original purchaser, for one years from purchase date to be free of defects in material and workmanship.

This warranty is the only written or express warranty given by Toastmaster Inc. This warranty gives you specific legal rights. You may have other rights which vary from state to state. ANY OTHER RIGHT WHICH YOU MAY HAVE, INCLUDING ANY IMPLIED WARRANTY OF MERCHANTABILITY OR FITNESS FOR A PARTICULAR PURPOSE IS LIMITED IN DURATION TO THE DURATION OF THIS WARRANTY.

Defective product may be brought or sent (freight prepaid) to an authorized service center listed in the phone book, or to Service Department, Toastmaster Inc., 708 South Missouri St., Macon, MO 63552, for free repair or replacement at our option.

Your remedy does not include: cost of inconvenience, damage due to product failure, transportation damages, misuse, abuse, accident or the like, or commercial use. IN NO EVENT SHALL TOASTMASTER INC. BE LIABLE FOR INCIDENTAL OR CONSEQUENTIAL DAMAGES.

Some states do not allow limitations on how long an implied warranty lasts, or allow the exclusion or limitation of incidental or consequential damages, so the above limitations or exclusions may not apply to you.

For information, write Consumer Claims Manager, at the Macon address. Send name, address, zip, telephone area code and daytime number, model, serial number, and purchase date.

### KEEP DATED SALES RECEIPT FOR WARRANTY SERVICE.

Keep this booklet. Record the following for reference:

Date purchased \_\_\_\_\_

Model number \_\_\_\_\_

Date code (on bottom) \_\_\_\_\_

### **Toastmaster Inc.**

National Service Center  
708 South Missouri St.  
Macon, MO 63552

In USA and Canada call:  
Consumer Service 1-800-947-3744  
Consumer Parts 1-800-947-3745  
Hours: 8:00 a.m.- 4:30 p.m. CST

### CONTACT US/APPELEZ



**1-800-947-3744**



**[www.toastmaster.com](http://www.toastmaster.com)**



**[consumer\\_relations@toastmaster.com](mailto:consumer_relations@toastmaster.com)**

PART NO. 32709P01